



 **Matis**

Oseti razliku!  
Feel the difference!

**NAMJEŠTAJ 2018**



MODERAN DIZAJN I FUNKCIONALNOST  
ČINE VAŠ STIL ŽIVOTA KVALITETNIJIM!

---

*MODERN DESIGN AND FUNCTIONALITY  
MAKE YOUR LIFE STYLE BETTER!*



---

© 2018 Matis d.o.o. - Ivanjica

Sva prava zadržana. Nijedan deo ovog kataloga ne može biti reprodukovan bez pisane saglasnosti vlasnika prava. Predmeti korišćeni za dekoraciju, ugradna i bela tehnika, nisu predmet reklamiranja u ovom katalogu. Dimenzije su prikazane po principu širina x dubina x visina. Sve fotografije u ovom katalogu su simbolične.

Prevod na engleski jezik istaknut je italikom-zakošenim pismom.

© 2018 Matis d.o.o. - Ivanjica

*All rights reserved. Content may not be reproduced, downloaded, disseminated, published, or transferred in any form or by any means, except with the prior written permission of right owner. Decorations and kitchen appliances used in the pictures are not the subject of advertisement in this catalogue. Dimensions are representing the principle of width by depth by height. All photographs in this catalogue are symbolic.*

*English translation is written in italic letters.*



**SEDIŠTE:** SRBIJA / IVANJICA / Šume bb

**INFRASTRUKTURA**

5 fabričkih linija za serijsku proizvodnju pločastog nameštaja u Ivanjici  
3 fabričke linije za proizvodnju tapaciranog nameštaja u Rumi  
4 fabričke linije za serijsku proizvodnju nameštaja od masiva u Ivanjici  
2 fabričke linije za serijsku proizvodnju dušeka u Ivanjici

**POVRŠINA:** 60000 m<sup>2</sup> proizvodnog i magacinskog kapaciteta

**MALOPRODAJA:** 35 maloprodajnih salona u zemlji i inostranstvu

**BROJ ZAPOSLENIH:** Preko 1050 zaposlenih. Prosečna starost 30 godina.

**TEHNOLOGIJA:** CNC / kompjuterski upravljane mašine

**HEADQUARTERS:** SRBIJA / IVANJICA / Šume bb

**INFRASTRUCTURE**

*5 chip-board furniture production lines in Ivanjica*

*3 upholstery production lines in Ruma*

*4 solid wood furniture production lines in Ivanjica*

*2 mattress production lines in Ivanjica*

**USEFULL AREA:** 60000 m<sup>2</sup> covered in production lines and warehouses

**RETAIL:** 35 retail stores in Serbia and abroad

**EMPLOYEES:** Over 1050 employees. Average age 30 years old.

**TEHNOLOGY:** CNC

**KORPORATIVNI VIDEO KOMPANIJE MATIS:**

**CORPORATE VIDEO OF MATIS COMPANY :**

<https://www.youtube.com/watch?v=pj4gSyBXIGo>



**"Matis"** d.o.o. - je kompanija osnovana 2002. godine sa ciljem da proizvodi nameštaj od pločastih materijala i vizijom da bude regionalni lider u proizvodnji i kvalitetu proizvoda.

Kroz svaki komad našeg nameštaja, veoma lako ćete prepoznati principe kojim se rukovodi firma od osnivanja.

Zato smo i usvojili slogan:

## Oseti razliku!

*"Matis" d.o.o. - was established in 2002 with the aim to produce furniture made of chip-board, with the vision to become regional leader in the production and quality of its products.*

*Through each and every piece of furniture we make, you will easily recognize principles we follow in our business from the start.*

*That's why we adopted the motto:*

## Feel the difference!

Dragomir Lazović

A handwritten signature in blue ink, appearing to read 'D. Lazović', positioned below the printed name.

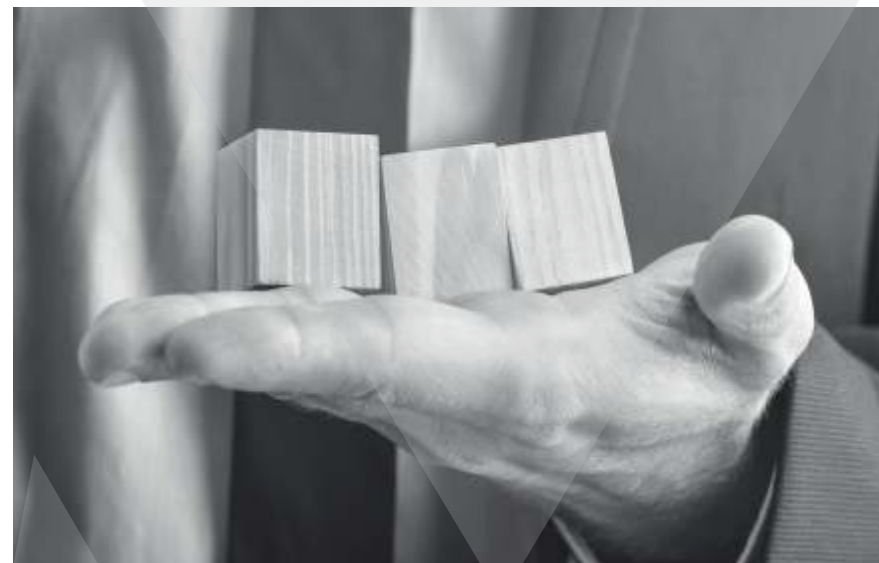



52. međunarodni sajam nameštaja - 2015.



"Zlatni ključ" za najkvalitetniji proizvod u kategoriji  
Nameštaj za odmor (krevet, trosedi, dvosedi i fotelje) 2015.

*Golden Key award for the best quality product in the category  
of seating furniture (beds, three-seaters, two-seaters and armchairs) 2015.*



Biznis partner 2007 / *Business Partner 2007.*

Najbolje srednje preduzeće u Srbiji za 2011.

*Pro Business leader in Serbia for 2011.*

Najbolje srednje preduzeće u Srbiji za 2012.

*Pro Business leader in Serbia for 2012.*



Najdinamičniji razvoj u 2011. godini

*The most dynamic development in 2011.*



Najbolji proizvođač kuhinja i  
kuhinjskog nameštaja u Srbiji za 2016.

*Best manufacturer of kitchen and  
kitchen furniture in Serbia for 2016.*



Kvalitet proizvoda - Najbolja dečija soba Happy  
Beogradski sajam nameštaja 2011.

*Quality product - The best children room Happy  
Belgrade Furniture Fair 2011.*



Nagrada za ukupan nastup i estetski izgled  
Beogradski sajam nameštaja 2014.

*The prize for overall performance  
and aesthetic appearance  
Belgrade Furniture Fair 2014.*



Nagrada za najbolje uređen štand  
Beogradski sajam nameštaja 2015.

*The prize for the best decorated stand  
Belgrade Furniture Fair 2015.*



Zlatna plaketa u kategoriji  
korporativni brend - Nameštaj 2015.

*Gold plaque in the category  
corporate brand - Furniture 2015.*





Sertifikat bonitetne izvrsnosti - 2015.  
*Certificate of Prudential Excellence - 2015.*



Zlatni ključ - Nagrada za ukupan sajamski nastup  
Beogradski sajam nameštaja 2017.

*Golden key- Prize for total fair appearance  
Belgrade Furniture Fair 2017.*

Sa ponosom predstavljamo partnere i njihove materijale od kojih je sastavljen kompletan MATIS nameštaj.  
*We are proud to present our business partners and their materials used to produce all MATIS furniture.*

Frontovi iverica 18 mm <i>Front chipboards 18 mm</i>			Sjaj/Gloss 
Korpusi iverica 18 mm <i>Corps chipboards 18 mm</i>			 wood industry
Radne ploče 38 i 28 mm <i>Worktops 38 i 28 mm</i>			
Ručice <i>Handles</i>			metal ili aluminijum <i>metal or aluminium</i>
Kant trake <i>Edge bands</i>			ABS 1 & 2 mm <a href="http://www.blazic.eu">www.blazic.eu</a> edge bands
Tehnologija izrade <i>Technology</i>			
Tehnologija lepljenja <i>Adhesives technology</i>			
Okovi <i>Okovi</i>			 
Matis profili <i>MDF battens</i>			





# Kuhinja

*Kitchen*





# Rustik

## Rustic

Kuhinja predstavlja istinsko srce svakog doma. Stoga, kompanija Matis je pred sebe postavila izazov da Vam ponudi moderne i elegantne kuhinje, koje će istovremeno buditi toplinu tradicionalnog porodičnog domaćinstva - tako su nastale Kuhinje Rustik. Izrađene od medijapana (MDF-a) presvučenog PVC folijom, Kuhinje Rustik spadaju u sam vrh kada je kvalitet u pitanju. Ono što Kuhinje Rustik dodatno izdvaja je njihov jedinstveni rustični dizajn, sa ručicama specijalno izrađenim kombinacijom drvo - metal samo za ovu liniju proizvoda. Proverite zašto su kuhinje Rustik pravi hit na domaćem tržištu.

*The kitchen represents the true heart of every home. Therefore, the company Matis faced a challenge to offer you modern and elegant cuisine, which at the same time will awaken the warmth of a traditional family household - so kitchen Rustic was created. Made of MDF-coated PVC foil, RustiC kitchens belong to the very top when quality is concerned. What kitchens RustiC extracts is their unique rustic design, with handles with a specially made wood-metal combination just for this product line. Check out why kitchens Rustic a hit on the domestic market.*







Tradicionalnog i modernog izgleda idealna za sve vrste domova. Frontovi su izrađeni od medijapana i opremljeni nečujnim i „usporenim“ sistemom zatvaranja koji sprečava oštećenja. Frontovi su izrađeni italijanskom vakuum tehnologijom. Kvalitet okova garantuje kvalitet i funkcionalnost.

*Traditional and modern looks ideal for all types of homes. Fronts are made of MDF and equipped with silent and "slow" closing system that prevents damage. Fronts are made by Italian vacuum technology. Quality of fittings guarantees quality and functionality.*



**MADE IN ENGLAND**

**Titus**+

Usporivači za sve frontove  
*Compressors for all front*



**rd** ruzjdesign  
handles

**Ručice RUSTIK**

Ručice kod elemenata su izrađene od kombinacije drvo - metal sa završnom obradom eloksažom (nije farbana) tako da se ne može desiti da se ručica od upotrebe pohaba i izgrebe. Dimenzija ručica je 160 mm

**Handle RUSTIC**

*The handle elements are made of combination of wood - metal with finish anodising (not dyed) so that it can not happen that the lever of use frayed and scratched. The dimension of the handle is 160 mm.*



2,8 m  
Završna lajsna - rustik belo  
Finishing battens - rustic white  
ID KZL43

4 m  
ID KDL3704

ID KDL624

2 m  
3 m  
4 m  
Podna lajsna PVC - bela, siva  
Plinth - white, gray

ID 070909 - 2m + 2 ugaonika/corners  
ID 071109 - 3m + 3 ugaonika/corners  
ID 071009 - 4m + 4 ugaonika/corners

bela  
white

ID 070922 - 2m + 2 ugaonika/corners  
ID 071122 - 3m + 3 ugaonika/corners  
ID 071022 - 4m + 4 ugaonika/corners

Diht lajsna PVC - aida orah, san remo  
PVC upstand - aida walnut, san remo

siva metalik  
grey metallic

- 1 Par bočnih stranica: 114x28x2,5 cm  
Pair of sides: 114x28x2,5 cm
- 2 Radna ploča pulta: 38 mm (sa pripadajućim leđima)  
Desk top panel: 38 mm (With their back)
- 3 Front: 40x101 cm / Front: 40x101 cm
- 4 Front: 30x101 cm / Front: 30x101 cm

## RUSTIK kuhinja sa pultom

RUSTIC kitchen with counter



- \* Dužina radne ploče definisana je Vašim izborom frontova.
- \* Length of worktop is defined by Your choice of fronts.

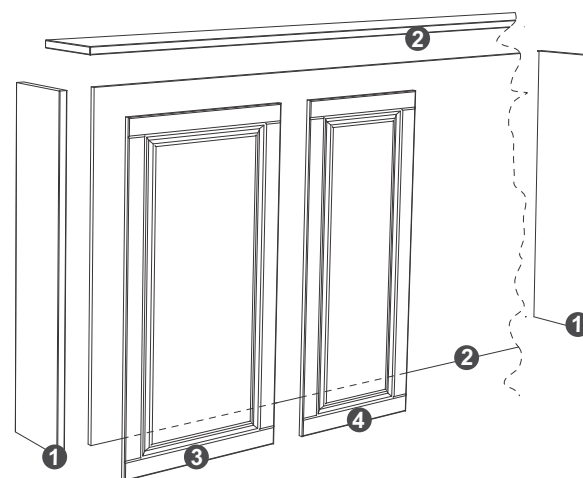
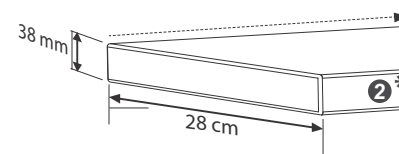



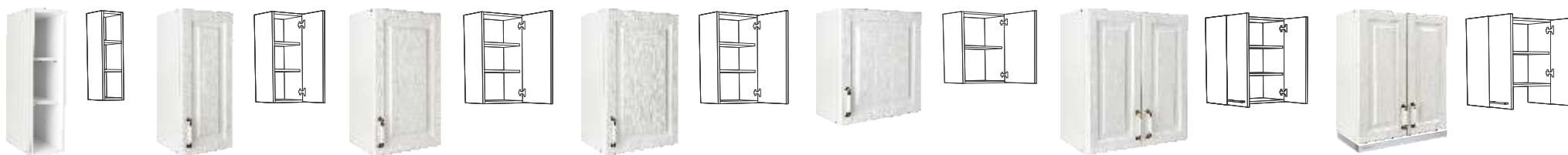

**RUSTIK V20**  
20 x 29 x 72 cm  
ID KV 2009

**RUSTIK V30**  
30 x 31 x 72 cm  
ID KV 3043

**RUSTIK V40**  
40 x 31 x 72 cm  
ID KV 4043

**RUSTIK V45**  
45 x 31 x 72 cm  
ID KV 4543

**RUSTIK VA50**  
50 x 31 x 57cm  
ID KVA 5043

**RUSTIK V60**  
60 x 31 x 72 cm  
ID KV 6043

**RUSTIK VA60-68**  
60 x 31 x 68 cm  
ID KVA 606843



**RUSTIK VA60**  
60 x 31 x 57 cm  
ID KVA 6043

**RUSTIK VU60**  
60/31 x 60/31 x 72 cm  
ID KVV 6043

**RUSTIK VH60**  
60 x 31 x 72 cm  
ID KVH 6043

**RUSTIK VH80**  
80 x 31 x 72 cm  
ID KVH 8043

**RUSTIK V80**  
80 x 31 x 72 cm  
ID KV 8043

\* Svi elementi sa jednim krilom imaju mogućnost univerzalnog otvaranja \* All elements with one front have possibility of universal opening

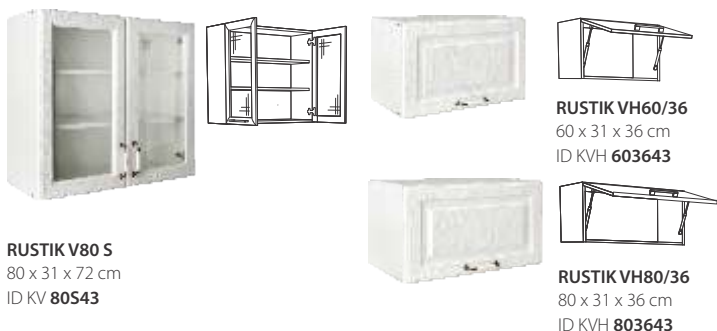

**RUSTIK VH60/36**  
60 x 31 x 36 cm  
ID KVH 603643

**RUSTIK VH80/36**  
80 x 31 x 36 cm  
ID KVH 803643

**RUSTIK V80 S**  
80 x 31 x 72 cm  
ID KV 80543

<b>18 mm</b> Univer Chipboard Korpus / Corps		<b>19 mm</b> Rustic Lice / Front	
belo white		rustik belo rustic white	
<b>38 mm</b> Radna ploča / Worktop			
104	276	166	3704
bež beige	arkosa pesak sand arcossa	aurora bianco	aida orah aida walnut
		131	624
		dekor. mermer decor. marble	san remo san remo

Dimenzije su prikazane po principu širina x dubina x visina.  
Dimensions are representing the principle of width by depth by height.



**RUSTIK D60 RV**  
60 x 57 x 222 cm  
ID KD 60RV43



**RUSTIK FRIZ 60 / OSTAVA**  
RUSTIK FRIZ 60 / Fridge cabinet  
60 x 57 x 222 cm  
ID KFRIZ43

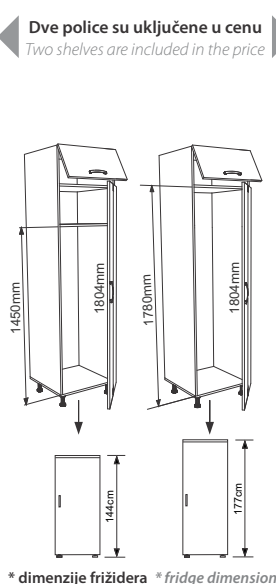

\* dimenzije frižidera \* fridge dimension



**RUSTIK FRIZ 2V**  
60 x 57 x 222 cm  
ID KFRIZ2V 43

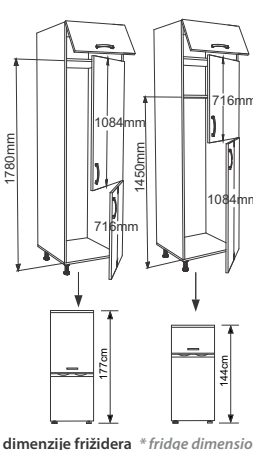

\* dimenzije frižidera \* fridge dimension



**RUSTIK D20 ŽICA**  
RUSTIK D20 pull out wire  
20 x 60 x 85 cm  
ID KD 2043



**RUSTIK D30**  
30 x 60 x 85 cm  
ID KD 3043



**RUSTIK D40 K**  
40 x 60 x 85 cm  
ID KD 40K43



**RUSTIK D40 F**  
40 x 60 x 85 cm  
ID KD 40F43



**RUSTIK D45 KF**  
45 x 60 x 85 cm  
ID KD 45KF43



**RUSTIK D60**  
60 x 60 x 85 cm  
ID KD 6043



**RUSTIK DU100**  
100 x 60 x 85 cm  
ID KDU 10043



**RUSTIK DU 2K**  
100 /60 x 100/60 x 85 cm  
ID KDU 2K43



**RUSTIK D80**  
80 x 60 x 85 cm  
ID KD 8043



**RUSTIK D80 S**  
80 x 60 x 82 cm  
ID KD 80S43

SUDOPERE SE  
POSEBNO NARUČUJU!  
Sink are sold separately!



**RUSTIK D40 F PL-BOX**  
40 x 60 x 85 cm  
ID KD 40FPLB43

**emuca**  
Metal Box  
SLOW MOTION



**RUSTIK D60 F PL-BOX**  
60 x 60 x 85 cm  
ID KD60FPLB43



**RUSTIK D60 F**  
60 x 60 x 85 cm  
ID KD 60F43

TELESKOPSKI KLIZAČI  
telescopic slides



**RUSTIK D60 R**  
60 x 60 x 85 cm  
ID KD 60R43

FRONT MAŠINE ZA SUDOVE sa ručicom  
DISHWASHER PANEL with handle

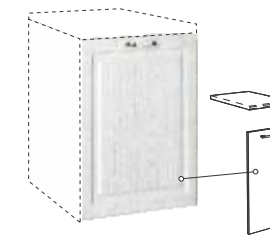

**RUSTIK MASKA 45 x 72**  
45 x 72 x 1,8 cm  
ID KMAS 457243

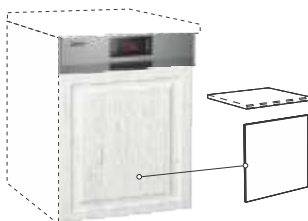

RADNA PLOČA SE POSEBNO NARUČUJE!  
Worktop is an extra order

FRONT MAŠINE ZA SUDOVE  
DISHWASHER PANEL  
**RUSTIK MASKA 60 x 60**  
60 x 60 x 1,8 cm  
ID KMAS 606043

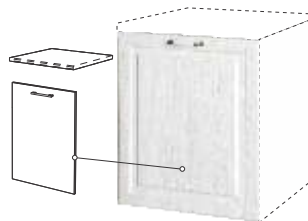

FRONT MAŠINE ZA SUDOVE sa ručicom  
DISHWASHER PANEL with handle

**RUSTIK MASKA 60 x 72**  
60 x 72 x 1,8 cm  
ID KMAS 607243

**55 cm**

Dubina korpusa donjih elemenata  
Corps depth of lower elements

**18 mm**

Univer  
Chipboard

**19 mm**

Rustic

**ABS**

**0,4 mm**

Kant traka  
Edge Band

**R**

Rustik  
Ručica  
Handle

SLOW  
CLOSING

Oprema  
Equipment

Nogari  
Stands

PLANA  
BOX

Fioka  
Drawer

**38 mm**

Radna ploča  
Worktop

**60 N Gas**

Oprema  
Equipment

**30kg**

Teleskop fioka  
Telescopic

Slow  
motion

Zatvaranje  
Closing



# IN MDF

IN MDF

Kuhinje IN MDF (od medijapana), proizvedene na vakuumskoj presi, obložene PVC folijom, predstavljaju vrhunac u proizvodnji nameštaja. U odnosu na farbani medijapan kuhinje proizvedene na italijanskoj tehnologiji, nemačkoj PVC foliji i medijapanu, odlikuju se većom otpornošću na habanje, udarce i grebanje.

U ponudi su najmoderniji dezeni u visokom sjaju: belo, bež, bordo, violet, jasen sjaj i u matu dezen aida trešnja. Svi korpusni delovi kuhinja IN MDF su u beloj boji debljine 18 mm. Radne ploče su debljine 38 mm sečene na meru koju želi kupac. U ponudi je 6 modernih dezena, koji se savršeno uklapaju sa ponuđenim dezenima frontova. Ram za stakleno krilo je takođe od medijapana, urađen iz jednog komada, bez ikakvih spojeva i lepljenja.

Ovakve kuhinje upotpunjene su metalnom ručicom, modernog dizajna, predstavljaju idealno rešenje za svaki dom.

*Kitchens IN MDF ( MDF ) produced in a vacuum press, PVC -coated foil , poses a peak in the manufacture of furniture . In relation to the painted MDF kitchen produced on Italian technology, German PVC laminate and MDF, are characterized by a higher resistance to abrasion, impact and scratching.*

*We offer modern designs in high gloss : white , beige , bordeaux , violet , ash gloss and aida cherry mat . All parts of the corpus IN MDF kitchen are white colored with thickness of 18mm . Worktops are 38 mm thick , cutted by customer wishes . There are 6 modern designs that fit perfectly with the offered designs of fronts . Frame for glass front is also made of MDF , made from a single piece , with no joints and glue .*

*These kitchens complemented by an metal handle , modern designed are the ideal solution for every home .*









★  
VISOKI SJAJ  
HIGH GLOSS



**Titus**



**SLOW MOTION**  
Slow motion šarke  
*Slow motion hinge*



**PVC NOGARI**  
Sve IN MDF kuhinje su postavljene na PVC nogare.  
*All IN MDF kitchens are put on PVC stands.*

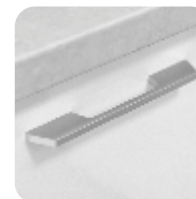

**Metalne ručice**  
*Metal handle*

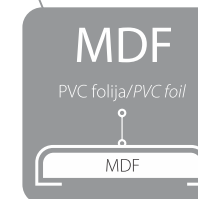

**MDF**  
PVC folija/PVC foil

MDF

Frontovi kuhinje IN MDF su izrađeni od medijapana (MDF-a, 19 mm) presvučenog PVC folijom. U godinama iza nas, MDF se izdvojio kao materijal koji u izradi kuhinjskih elemenata pokazuje brojne prednosti, čak i u poređenju sa masivom: povećana vodootpornost i otpornost na vodenu paru, lakoća obrade, kao i daleko niža cena. Izborom Kuhinja IN MDF dobijate veoma kvalitetan kuhinjski nameštaj, a široka ponuda dezena je garant da ćete pronaći elemente koji će zadovoljiti Vaše estetske standarde.

*Kitchen IN MDF fronts are made of mediapan (MDF, 19mm) PVC foil coated. In the years behind us, the MDF has distinguished itself as a material that produces numerous advantages in making of kitchens elements, even in comparison with the massive: increased waterproofing and water vapor resistance, easy processing, and much lower price. By choosing kitchen IN MDF You get high quality kitchen furniture and a wide range of patterns is guarantee that You will find elements that will satisfy Your aesthetic standards.*



#### Završna lajsna

Jasen sjaj, belo sjaj, bež sjaj,  
bordo sjaj, violet sjaj, aida trešnja

#### Finishing battens

Ash gloss, white gloss, beige gloss,  
dark red gloss, violet gloss, aida cherry

2,8 m



ID KZL53

ID KZL14

ID KZL33

ID KZL15

ID KZL32

ID KZL48

#### Diht lajsna PVC

aida orah, dekor. mermer, san remo,  
sivo, aurora bianco, bež, arkosa pesak

#### PVC upstand

aida walnut, decor marble, san remo,  
gray, arora bianco, beige, sand arcossa

4 m



ID KDL3704

ID KDL131

ID KDL624

ID 070601

ID KDL166

ID KDL104

ID KDL276

#### Podna lajsna PVC

bela, siva

*Plinth*  
white, gray

2 m

3 m

4 m

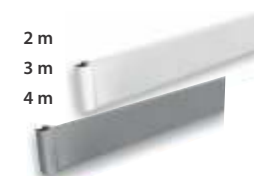

bela  
white



siva metalik  
grey metallic

ID 070909 - 2m + 2 ugaonika/corners

ID 071109 - 3m + 3 ugaonika/corners

ID 071009 - 4m + 4 ugaonika/corners

ID 070922 - 2m + 2 ugaonika/corners

ID 071122 - 3m + 3 ugaonika/corners

ID 071022 - 4m + 4 ugaonika/corners



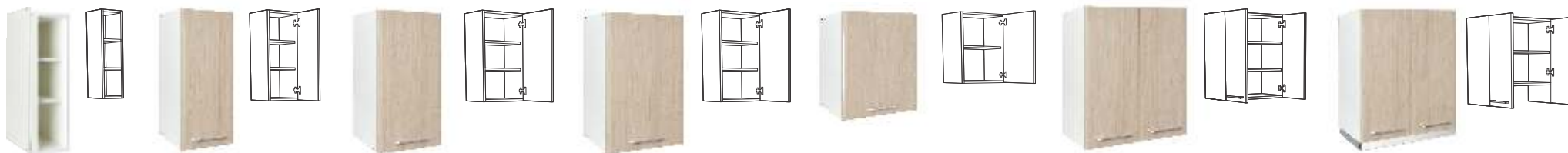

**IN MDF V20**  
20 x 29 x 72 cm  
ID KV 2009

**IN MDF V30**  
30 x 31 x 72 cm  
ID KV 30\*\*

**IN MDF V40**  
40 x 31 x 72 cm  
ID KV 40\*\*

**IN MDF V45**  
45 x 31 x 72 cm  
ID KV 45\*\*

**IN MDF VA50**  
50 x 31 x 57 cm  
ID KVA 50\*\*

**IN MDF V60**  
60 x 31 x 72 cm  
ID KV 60\*\*

**IN MDF VA60-68**  
60 x 31 x 68 cm  
IDKVA 6068\*\*

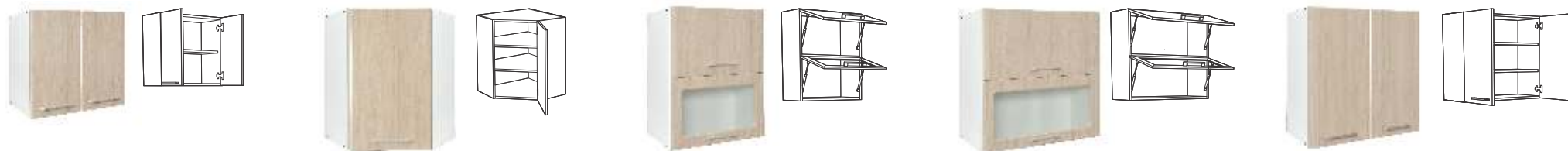

**IN MDF VA60**  
60 x 31 x 57 cm  
ID KVA 60\*\*

**IN MDF VU60**  
60/31 x 60/31 x 72 cm  
ID KVV 60\*\*

**IN MDF RVH60**  
60 x 31 x 72 cm  
ID KVH 60\*\*

**IN MDF VH80**  
80 x 31 x 72 cm  
ID KVH 80\*\*

**IN MDF V80**  
80 x 31 x 72 cm  
ID KV 80\*\*



**IN MDF VH60/36**  
60 x 31 x 36 cm  
ID KVH 6036\*\*

**IN MDF VH80/36**  
80 x 31 x 36 cm  
ID KVH 8036\*\*

\* Svi elementi sa jednim krilom imaju mogućnost univerzalnog otvaranja \* All elements with kitchen front have possibility of universal opening

**IN MDF V80 S**  
80 x 31 x 72 cm  
ID KV 80S\*\*

Korpus / Corps		Lice / Front						
<b>18 mm</b> Univer Chipboard	belo white	<b>19 mm</b> MDF	14 belo sjaj white gloss	33 bež sjaj beige gloss	15 bordo sjaj dark red gloss	32 violet sjaj violet gloss	53 jasen sjaj ash gloss	48 aida trešnja aida cherry

Radna ploča / Worktop						
<b>** 38 mm</b> Radna ploča Worktop	104 bež beige	276 arkosa pesak sand arcossa	166 aurora bianco aurora bianco	3704 aida orah aida walnut	131 dekor. mermer decor. marble	624 san remo san remo

NAPOMENA: Kompletna šifra elementa se dobija zamenom zvezdica \*\* sa dve cifre iz prikazanih dezena.  
NOTE: The complete code of an element is obtained by replacing stars\*\* with two digits of the displayed pattern.  
Dimenzije su prikazane po principu širina x dubina x visina.  
Dimensions are representing the principle of width by depth by height.



**IN MDF D60 RV**  
60 x 57 x 222 cm  
ID KD 60RV\*\*

**RUSTIK FRIZ 60 / OSTAVA**  
RUSTIK FRIZ 60 / Fridge cabinet  
60 x 57 x 222 cm  
ID KFRIZ43

**IN MDF FRIZ 2V**  
60 x 57 x 222 cm  
ID KFRIZ2V\*\*



**IN MDF D20 ŽICA**  
IN MDF D20 pull out wire  
20 x 60 x 85 cm  
ID KD 20\*\*

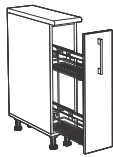

**IN MDF D30**  
30 x 60 x 85 cm  
ID KD 30\*\*



**IN MDF D40 K**  
40 x 60 x 85 cm  
ID KD 40K\*\*

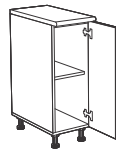

**IN MDF D40 F**  
40 x 60 x 85 cm  
ID KD 40F\*\*

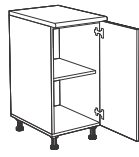

**IN MDF D45 KF**  
45 x 60 x 85 cm  
ID KD 45KF\*\*



**IN MDF D60**  
60 x 60 x 85 cm  
ID KD 60\*\*



**IN MDF DU100**  
100 x 60 x 85 cm  
ID KDU 100\*\*

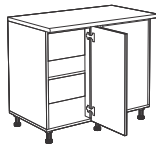

**IN MDF DU 2K**  
100/60 x 100/60 x 85 cm  
ID KDU 2K\*\*



**IN MDF D80**  
80 x 60 x 85 cm  
ID KD 80\*\*

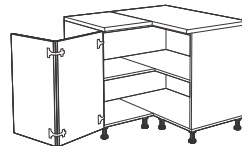

**IN MDF D80 S**  
80 x 60 x 82 cm  
ID KD 80S\*\*



**IN MDF D40 F PL-BOX**  
40 x 60 x 85 cm  
ID KD 40FPLB\*\*

**emuca**  
METAL BOX  
SLOW MOTION



**IN MDF D60 F PL-BOX**  
60 x 60 x 85 cm  
ID KD 60FPLB\*\*



**IN MDF D60 F**  
60 x 60 x 85 cm  
ID KD 60F\*\*



**IN MDF D60 R**  
60 x 60 x 85 cm  
ID KD 60R\*\*



**IN MDF MASKA 45 x 72**  
45 x 72 x 1,8 cm  
ID KMAS 4572\*\*

TELESKOPSKI KLIZAČI  
telescopic slides



RADNA PLOČA SE POSEBNO NARUČUJE!  
Worktop is an extra order



FRONT MAŠINE ZA SUDOVE  
DISHWASHER PANEL  
**IN MDF MASKA 60 x 60**  
60 x 60 x 1,8 cm  
ID KMAS 6060\*\*

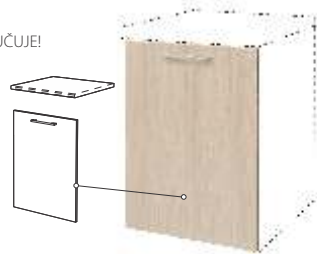

FRONT MAŠINE ZA SUDOVE sa ručicom  
DISHWASHER PANEL with handle

**IN MDF MASKA 60 x 72**  
60 x 72 x 1,8 cm  
ID KMAS 6072\*\*

SUDOPERE SE  
POSEBNO NARUČUJU!  
Sink are sold separately!

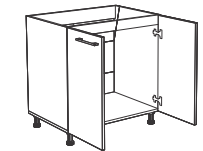

FRONT MAŠINE ZA SUDOVE sa ručicom  
DISHWASHER PANEL with handle

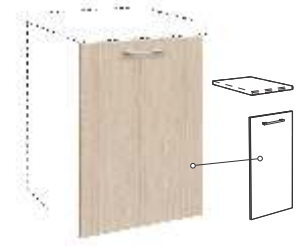

**55 cm**

Dubina korpusa donjih elemenata  
Corps depth of lower elements

**18 mm**

Univer  
Chipboard

**19 mm**

MDF

ABS  
**0,4 mm**

Kant traka  
Edge Band

**M**

Metal  
Ručica  
Handle



Oprema  
Equipment



Nogari  
Stands



Fioka  
Drawer

**38 mm**

Radna ploča  
Worktop



Oprema  
Equipment



Teleskop fioka  
Telescopic



Zatvaranje  
Closing



# IN

IN

Dekor u trendu i funkcionalnost elemenata osnovne su karakteristike kuhinje IN. Elementi na PVC nogarima omogućavaju bolju zaštitu i lakše održavanje kuhinje. Dubina korpusa je sada 55cm, broj elemenata je povećan na 33, donji elementi su na PVC nogarima sa PVC soklom. Ručice su metalne potpuno novog dizajna. Frontovi su okantovanisa sve 4 strane ABS 1 mm.

*Trendy decor and functionality of elements are basic features of the IN kitchen. Elements with the plastic legs provide better protection and easier maintenance of the kitchen. The corps depth is now 55 cm, number of elements is expanded to 33, standing elements are now on PVC stands with PVC plinths. Handles are made of metal and have completely new design. The fronts with edge on all 4 sides ABS 1 mm.*











Upotreba Univera u izradi kuhinjskih elemenata omogućila nam je da Vam ponudimo kuhinje koje izgledaju veoma luksuzno i moderno, a u isto vreme su izuzetno pristupačne. Kuhinje IN izrađuju se od najkvalitetnijeg 18mm Univera, sa jakim okovima i ivicama zaštićenim 1mm ABS trakom, čime smo stvorili proizvod takvog kvaliteta da razliku u odnosu na standardnu ponudu na tržištu možete primetiti na prvi pogled. Elementi su opremljeni nečujnim i "usporenim" sistemom zatvaranja koji sprečava oštećenja. U ponudi imamo veliki broj savremenih dezena koji garantuju uklapanje u bilo koji enterijer.

*The use of the University in making kitchen elements has enabled us to offer you kitchens that look very luxurious and modern, and at the same time extremely affordable. Kitchens IN are made of the highest quality 18mm Univer, with strong brackets and edges protected by 1mm ABS band, thus creating a product of such quality that you can notice the difference from the standard offer on the market at first glance. Elements are equipped with silent end "slow" closing system that prevents damage. We offer a large number of modern designs that guarantee the fitting in any interior.*



rd ruzjdesign  
handles



Ručice IN  
Handle IN

MADE IN ENGLAND

Titus+



Usporivači za sve frontove  
Compressors for all fronts



Radna ploča 28 mm  
Worktop 28 mm



PVC NOGARI  
Sve IN MDF kuhinje su postavljene na PVC nogare.  
All IN MDF kitchens are put on PVC stands.

55 cm

Dubina korpusa donjih elemenata  
Corps depth of lower elements

ABS

1

mm

Kant traka  
Edge Band

Završna lajsna  
sonoma hrast,  
bambus, sivi hrast, snežni hrast

Finishing battens

sonoma oak,  
bamboo, gray oak, snow oak

2,8 m

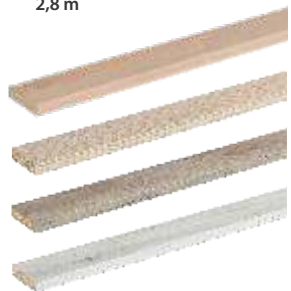

ID KZL12

ID KZL31

ID KZL44

ID KZL46

Diht lajsna PVC

aurora bianco, arkosa pesak, siva, bež

PVC upstand

arora bianco, sand arcossa, gray, beige

4 m

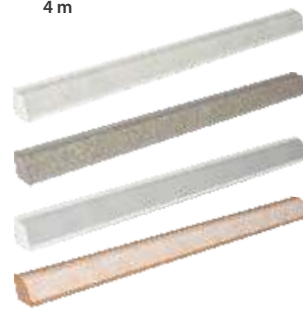

ID KDL166

ID KDL276

ID 070601

ID KDL104

Podna lajsna PVC

bela, siva

Plinth  
white, gray

2 m

3 m

4 m



bela  
white



siva metalik  
grey metallic

ID 070909 - 2m + 2 ugaonika/corners  
ID 071109 - 3m + 3 ugaonika/corners  
ID 071009 - 4m + 4 ugaonika/corners

ID 070922 - 2m + 2 ugaonika/corners  
ID 071122 - 3m + 3 ugaonika/corners  
ID 071022 - 4m + 4 ugaonika/corners







Ono što karakteriše MATIS kuhinje i izdvaja ih od ostalih je odabir materijala od kojih su izrađene. MATIS kuhinje izrađene su od oplemenjenog univerza debljine 18mm renomiranih svjetskih proizvođača Egger i Kronospan, dok je debljina radne ploče 28mm.

*What characterizes MATIS kitchens and segregates them from the rest is selection of the materials they are made of. MATIS kitchens are made of 18mm thick refined chipboard from renowned manufacturers Egger and Cronospan, with worktop thickness of 28mm*



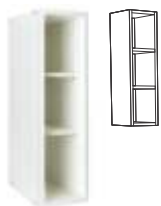

**IN V20**  
20 x 29 x 72 cm  
ID KV 2009



**IN V30**  
30 x 31 x 72 cm  
ID KV 30\*\*



**IN V40**  
40 x 31 x 72 cm  
ID KV 40\*\*



**IN V45**  
45 x 31 x 72 cm  
ID KV 45\*\*



**IN VA50**  
50 x 31 x 57 cm  
ID KVA 50\*\*



**IN V60**  
60 x 31 x 72 cm  
ID KV 60\*\*



**IN VA60-68**  
60 x 31 x 68 cm  
ID KVA 6068\*\*



**IN VA60**  
60 x 31 x 57 cm  
ID KVA 60\*\*

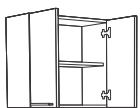

**IN VU60**  
60/31 x 60/31 x 72 cm  
ID KVV 60\*\*



**IN VH60**  
60 x 31 x 72 cm  
ID KVH 60\*\*

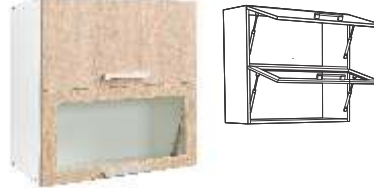
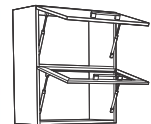

**IN VH80**  
80 x 31 x 72 cm  
ID KVH 80\*\*



**IN V80**  
80 x 31 x 72 cm  
ID KV 80\*\*



**IN V80 S**  
80 x 31 x 72 cm  
ID KV 80S\*\*

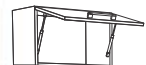
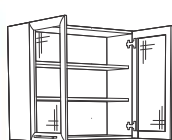

**IN VH60/36**  
60 x 31 x 36 cm  
ID KVH 6036\*\*



**IN VH80/36**  
80 x 31 x 36 cm  
ID KVH 8036\*\*

\* Svi elementi sa jednim krilom imaju mogućnost univerzalnog otvaranja \* All elements with one front have possibility of universal opening

Dve police su uključene u cenu  
Two shelves are included in the price



**IN D60 RV**  
60 x 57 x 222 cm  
ID KD 60RV\*\*

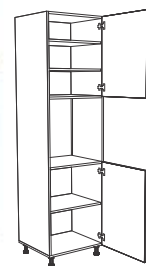

**IN FRIZ 60 / OSTAVA**  
60 x 57 x 222 cm  
ID KFRIZ\*\*

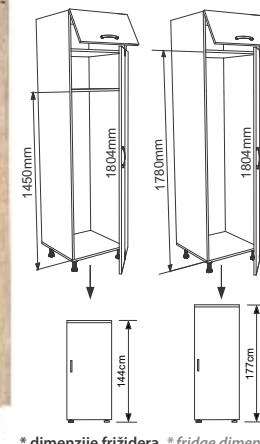

\* dimenzije frižidera \* fridge dimension



**IN FRIZ 2V**  
60 x 57 x 222 cm  
ID KFRIZ2V\*\*

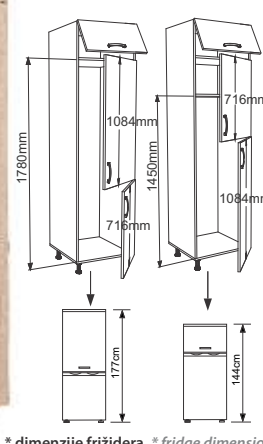

\* dimenzije frižidera \* fridge dimension

**Korpus / Corps**

**18 mm** Univer Chipboard

**18 mm** Univer Chipboard

**Lice / Front**

**12** sonoma hrast / sonoma oak

**31** bambus / bamboo

**44** sivi hrast / gray oak

**46** snežni hrast / snow oak

---

**Radna ploča / Worktop**

**\*\* 28 mm** Radna ploča / Worktop

**104** bež / beige

**276** arkosa pesak / sand arcossa

**166** aurora bianco / aurora bianco

NAPOMENA: Kompletna šifra elementa se dobija zamenom zvezdica \*\* sa dve cifre iz prikazanih dezena.  
NOTE: The complete code of an element is obtained by replacing stars\*\* with two digits of the displayed pattern.





**IN D20 ŽICA**  
IN D20 pull out wire  
20 x 60 x 85 cm  
ID KD 20\*\*

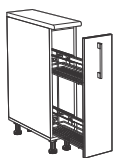

**IN D30**  
30 x 60 x 85 cm  
ID KD 30\*\*

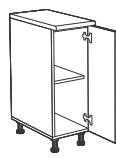

**IN D40 K**  
40 x 60 x 85 cm  
ID KD 40K\*\*

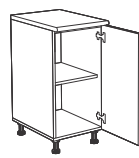

**IN D40 F**  
40 x 60 x 85 cm  
ID KD 40F\*\*



**IN D45 KF**  
45 x 60 x 85 cm  
ID KD 45KF\*\*



**IN D60**  
60 x 60 x 85 cm  
ID KD 60\*\*



**IN DU100**  
100 x 60 x 85 cm  
ID KDU 100\*\*



**IN DU 2K**  
100 /60 x 100/60 x 85 cm  
ID KDU 2K\*\*



**IN D80**  
80 x 60 x 85 cm  
ID KD 80\*\*

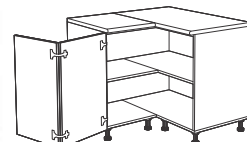

**IN D80 S**  
80 x 60 x 82 cm  
ID KD 80S\*\*



SUDOPERE SE  
POSEBNO NARUČUJU!  
*Sink are sold separately!*

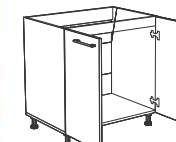

TELESKOPSKI KLIZAČI  
*telescopic slides*



**IN D60 F**  
60 x 60 x 85 cm  
ID KD 60F\*\*



**IN D60 R**  
60 x 60 x 85 cm  
ID KD 60R\*\*



FRONT MAŠINE ZA SUDOVE sa ručicom  
DISHWASHER PANEL with handle  
**IN MASKA 45 x 72**  
45 x 72 x 1,8 cm  
ID KMAS 4572\*\*

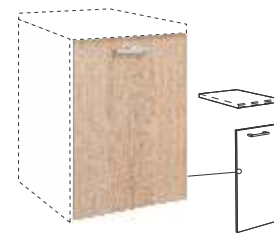

FRONT MAŠINE ZA SUDOVE  
DISHWASHER PANEL  
**IN MASKA 60 x 60**  
60 x 60 x 1,8 cm  
ID KMAS 6060\*\*

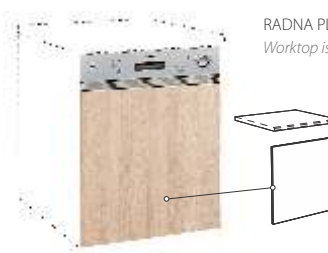

RADNA PLOČA SE POSEBNO NARUČUJE!  
*Worktop is an extra order*

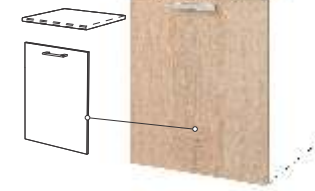

FRONT MAŠINE ZA SUDOVE sa ručicom  
DISHWASHER PANEL with handle  
**IN MASKA 60 x 72**  
60 x 72 x 1,8 cm  
ID KMAS 6072\*\*

**55 cm**  
Dubina korpusa donjih elemenata  
*Corps depth of lower elements*

**18 mm**  
Univer Chipboard

**28 mm**  
Radna ploča  
Worktop

**M**  
Metal  
Ručica  
Handle

**ABS**  
**0,4 mm**  
Kant traka  
Edge Band

**ABS**  
**1 mm**  
Kant traka  
Edge Band

**Nogari**  
Stands

**Slow motion**  
Zatvaranje  
Closing

**60 N Gas**  
Oprema  
Equipment

**30kg**  
Teleskop fioke  
Telescopic

**SLOW CLOSING**  
Oprema  
Equipment

Dimenzije su prikazane po principu širina x dubina x visina.

*Dimensions are representing the principle of width by depth by height.*

# BLOK KUHINJE 200

*Block kitchens 200*

Blok kuhinje predstavljaju optimalnu kombinaciju donjih i gornjih kuhinjskih elemenata u odnosu na datu površinu. Kupovinom Blok kuhinja, dobijate konfiguraciju koja sadrži sve osnovne kuhinjske elemente neophodne prosečnom korisniku. Osim po praktičnosti, Blok kuhinje kompanije Matis izdvajaju se i po veoma pristupačnoj ceni.

*Kitchen block represents optimal combination of the lower and upper kitchen elements in relation to the given surface. By purchasing Kitchen block you get a configuration that contains all the basic kitchen elements necessary for the average use. Except for practical use, Matis Kitchen Blocks are also available at a very affordable price.*



1 Blok kuhinja 200 / Block kitchen 200 ID 031546 2 V60A / V60A ID 036046



200 cm

68 cm



PVC NOGARI

Univer sokla/Chipboard plinth

Kuhinja "Standard 200" hrast

*Kitchen "Standard 200" oak*

ID **031512**

Opcioni element V60A

*Optional element V60A*

ID **036012**



**V60A ID 036046**  
 Opcioni element  
*Optional element*

**BLOK KUHINJA 200 / snežni hrast** *BLOCK KITCHEN 200 / snow oak*

**ID 031546**

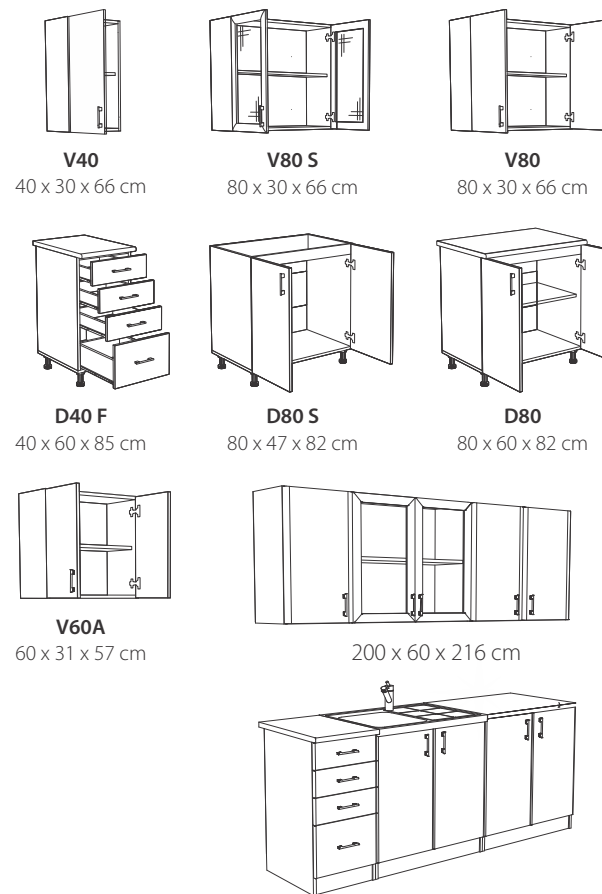

Završna lajsna - hrast, snežni hrast  
*Finishing battens - oak, snow oak*



Podna lajsna-sokla-bela univer  
*Plinth - white chipboard*



Diht lajsna PVC - boja ALU  
*PVC upstand - color ALU*

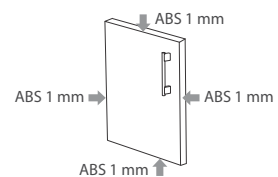

FRONTOVI KANTOVANI SA 4 STRANE  
*Four side edge banding of front doors*



**PVC NOGARI**

Za lakše održavanje i bolju zaštitu  
*For better maintenance and protection*



Metalne ručice  
*Metal handle*

Lice / Front Radna ploča / Worktop Korpus / Corps Lice / Front Radna ploča / Worktop



hrast  
 oak



belo  
 white



belo  
 white



snežni hrast  
 snow oak



sivo  
 gray

**45 cm**  
 Dubina korpusa donjih elemenata  
*Corps depth of lower elements*

**18 mm**  
 Univer  
 Chipboard

**28 mm**  
 Radna ploča  
 Worktop

**Nogari**  
 Stands

**ABS**  
**1 mm**  
 Kant traka  
 Edge Band

**ABS**  
**0,4 mm**  
 Kant traka  
 Edge Band

**M**  
**Metal**  
 Ručica  
 Handle

# SUDOPERE

Kitchen sinks



**Alveus**



**BASIC 150**

Usadna sudopera univerzalna  
Inset universal sink  
780 x 435 mm • ID 070905

**Alveus**



**CLASSIC 30**

Nasadna sudopera leva i desna  
Undermount sink - left and right  
ID 070100 - DESNA / right  
ID 070200 - LEVA / left

**Alveus**



**CLASSIC 40**

Nasadna sudopera dvodelna  
Undermount sink  
ID 070300

**Metalac**



**C480F1M1**

Usadna sudopera okrugla  
Inset rounded sink  
Ø 480 mm • ID 070401

**Metalac**



**C480F1M1 B**

Usadna sudopera okrugla  
sa rupom za slavinu  
Rounded sink with faucet hole  
Ø 480 mm • ID 070501

**Metalac**



**1D465435FP1**

Usadna sudopera kockica  
Inset square sink  
465 x 435mm • ID 070901

**Alveus**



**FORM 10**

Usadna sudopera okrugla  
Inset rounded sink  
Ø 450 mm • ID 070903

**Alveus**



**FORM 30**

Usadna sudopera okrugla  
sa rupom za slavinu  
Rounded sink with faucet hole  
Ø 510 mm • ID 070904

**Alveus**



**BASIC 10**

Usadna sudopera kockica  
Inset square sink  
380 x 440 mm • ID 070906

**Metalac**



**1D770435FP**

Usadna sudopera univerzalna  
Inset universal sink  
770 x 435 mm • ID 070900

**Metalac**



Nasadna sudopera - leva i desna  
Undermount sink - left and right  
ID 070101 - DESNA / right  
ID 070201 - LEVA / left

**Metalac**



Nasadna sudopera 2D  
Undermount sink 2D  
ID 070301

# DODACI

## Accessories



### Završne lajsne IN MDF 2,8 m

Finishing battens IN MDF 2,8 m

jasen sjaj sjaj / ash gloss ID **KZL53**

belo sjaj / white gloss ID **KZL14**

bež sjaj / beige gloss ID **KZL33**

bordo sjaj / dark red gloss ID **KZL15**

violet sjaj / violet gloss ID **KZL32**

aida trešnja / aida cherry ID **KZL48**



### Završne lajsne IN 2,8 m

Finishing battens IN 2,8 m

sonoma hrast  
sonoma oak ID **KZL12**

bambus  
bamboo ID **KZL31**

sivi hrast  
gray oak ID **KZL44**

snežni hrast  
snow oak ID **KZL46**

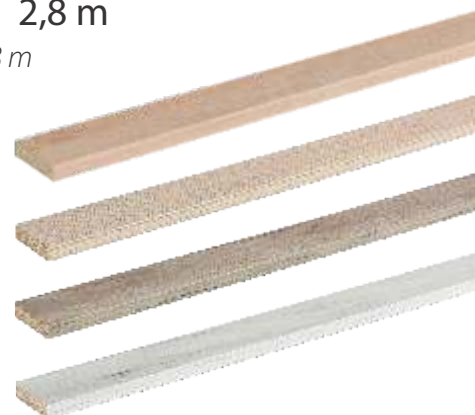

### Završne lajsne Rustik 2,8 m

Finishing battens Rustic 2,8 m

rustik belo  
rustic white

ID **KZL43**



### PVC Diht lajsne 4 m

PVC Upstands 4 m

IN MDF aida orah  
aida walnut ID **KDL3704**

IN MDF dekorativni mermer  
decorative marble ID **KDL131**

IN MDF / IN san remo / san remo ID **KDL624**

IN MDF / IN sivo / gray ID **070601**

IN MDF / IN aurora bianco  
aurora bianco ID **KDL166**

IN MDF / IN bež / beige ID **KDL104**

IN MDF / IN arkosa pesak  
sand arcossa ID **KDL276**



### Podne PVC lajsne - sokle

Plinths PVC

Podne lajsne za kuhinje  
bela, siva

Kitchen floor plinths  
white, grey



bela  
white



siva metalik  
grey metallic

ID **070909** - 2m + 2 ugaonika/corners  
ID **071109** - 3m + 3 ugaonika/corners  
ID **071009** - 4m + 4 ugaonika/corners

ID **070922** - 2m + 2 ugaonika/corners  
ID **071122** - 3m + 3 ugaonika/corners  
ID **071022** - 4m + 4 ugaonika/corners

2 m

3 m

4 m





# STOLOVI I STOLICE

*Dining tables and chairs*

Trpezarijski stolovi su centralni komad nameštaja u svakoj trpezariji. Izbor trpezarijskog stola uslovljava dizajn sitnijih komada trpezarijskog nameštaja, zbog čega je jako bitno da budete sigurni u njegovu stabilnost i postojanost tokom dugog niza godina. U Matis salonima nameštaja možete pronaći trpezarijske stolove svih oblika, dimenzija i dezena i sigurni smo da se u našoj ponudi krije jedan kao stvoren za Vas.

*Dining tables are a central piece of furniture in every dining room. The choice of dining table requires design of smaller pieces of dining furniture, because it is very important to be sure of its stability and consistency over many years. In Matis Furniture Showrooms you can find dining tables of all shapes, sizes and designs and we are sure that in our offer there is the one that is created for you.*

**Matis Wood**



# Praktik

Trpezarijski sto / Dinning table  
dimenzija/dimension: 80 x 80 x 75,5 cm

Dezeni / Colors



**Wenge**  
Wenge  
ID 080605



**Trešnja**  
Cherry  
ID 080603



**Hrast**  
Oak  
ID 080609



**Belo**  
White  
ID 080607

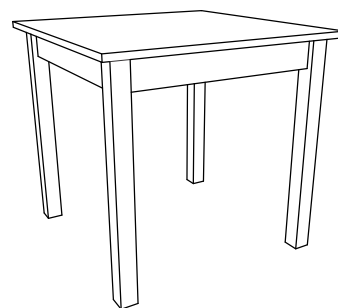

## TRPEZARIJSKI STOLOVI PRAKTIK

WOODY PRAKTIK sto je osmišljen, konstruisan i napravljen da bude čvrst, stabilan i postojan. Nogari su izrađeni od pažljivo biranog bukovog drveta, kvalitetno sušenog i obrađenog na najsavremenijim mašinama. Ploča stola je od obostrano furniranog medijapana debljine 17 mm. Veze između elemenata su ostvarene drvenim tiplovima i metalnim okovom. Praktik je fiksni sto, a u ponudi je paleta od 4 atraktivne boje.

## DINNING TABLE PRACTIC

Woody dining table Praktik was designed, engineered and built to be strong, stable and durable. The legs are made of carefully selected beech wood, well dried and processed on modern machines. The tabletop is made of 17 mm thick MDF. The links between the elements are made by wooden anchors and metal hardware. Praktik is a fixed table, made in four attractive colors.

# Praktik

Trpezarijski sto / Dinning table  
dimenzija/dimension: 120 x 80 x 75,5 cm

Dezeni / Colors



**Wenge**  
Wenge  
ID 080505



**Trešnja**  
Cherry  
ID 080503



**Hrast**  
Oak  
ID 080509



**Belo**  
White  
ID 080507

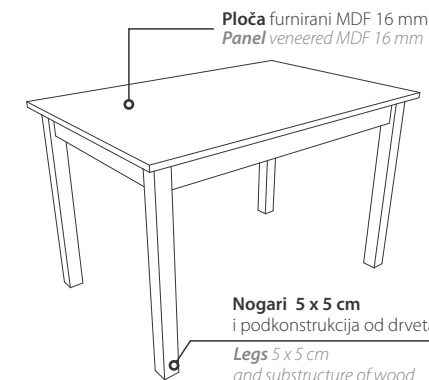

**1 JOŠ JAČE**  
Detalj spojenog nosećeg rama i ploče stola  
Spajanje nosećeg rama i ploče dodatno je, pored lepljenih drvenih tiplova, ojačano i sa ABS plastičnim ugaonim spojnicama.

**EVEN STRONGER**  
Detail of a connected body frame and tabletop

The joint of the frame and the tabletop was reinforced with abs plastic angle connectors in addition to laminated wooden dowels.



**3 LAKA MONTAŽA**  
Jednostavna montaža stola  
Velika pažnja je posvećena jednostavnoj i brznoj montaži što pokazuje vezivni spoj nogara i podkonstrukcije, čineći sto stabilnim.

**EASY ASSEMBLY**  
Easy assembly of the table

Great attention is paid to the simple and quick installation which shows the bonding joint of the leg and substructure, making it stable.



**2 TRAJNOSPONENTO**  
Detalj spojenih nogara i sarga stola  
Spoj nogara i ploče stola izveden je pomoću skrivene metalne spojnice što uz drvene tiplove omogućava čvrst spoj i dugogodišnju stabilnost.

**PERMANENTLY CONNECTED**  
Detail of legs and apron connection

The joint of the legs and tabletop is made by using a hidden metal coupling which with wooden anchors provides strong connection and long-term stability.



**4 DOBRO UPAKOVANO**  
Izgled složene transportne kutije  
Prikaz detalja pakovanja pre zatvaranja i lepljenja ivica sa jakom zaštitnom natron trakom.

**WELL PACKED**  
Picture of the folded transport box

Picture of package detail before closing and sealing the edges of the box with a strong protective paper tape.



**FURNIRANA PLOČA**  
Veneer tabletop

Nogari i podkonstrukcija od punog drveta  
Legs and substructure of wood



# Rustik

Trpezarijski sto / *Dinning table*  
 dimenzija/dimension: 120 x 80 x 75,5 cm

Belo / Aida orah  
 White / Aida walnut

ID 080538



## MatisWood



MDF ploča debljine 19 mm presvučena folijom  
 MDF panel thickness of 19 mm coated with foil  
 Nogari i podkonstrukcija od punog drveta  
 Legs and substructure of wood

# ML 8 Plus

Trpezarijski sto / *Dinning table*  
dimenzija/dimension: 144/181 x 103 x 77 cm



Wenge / *Wenge*  
ID MITA158



Belo / *White*  
ID MITA152



Sto na razvlačenje  
*Extendable dining table*



# ML 7 Plus

Trpezarijski sto / *Dinning table*  
dimenzija/dimension: 100/140x103x77 cm



Wenge  
*Wenge*

ID MITA153



Belo  
*White*

ID MITA151

Sto na razvlačenje  
*Extendable dining table*



# Stolice Queen

Trpezarijske stolice / Dining Chairs  
dimenzija/dimension: 42 x 45 x 95 cm

Dezeni / Colors



Belo White  ID MITA090101/2

Bukva Beech  ID MITA090101

## Queen

ID MITA090103  
trešnja / cherry



ID MITA090106  
wenge / wenge



ID MITA090101 / 1  
hrast / oak



Belo White  ID MITA090202

Bukva Beech  ID MITA090201

## Queen LUX

ID MITA090203  
trešnja / cherry



ID MITA090206  
wenge / wenge



ID MITA090212  
hrast / oak



Belo White  ID MITA090302

Bukva Beech  ID MITA090301

## Queen PLUS

ID MITA090303  
trešnja / cherry  
sivi štof  
gray cloth



ID MITA090306  
wenge / wenge



ID MITA090312  
hrast / oak



# Stolice Jelena

Trpezarijske stolice / Dining Chairs  
dimenzija/dimension: 47 x 47 x 105 cm

Dezeni / Colors



**Wenge**  
Wenge

**Hrast**  
Oak

**Belo**  
White

Trpezarijska stolica Jelena ima značajnu ulogu u uređenju kuhinje, jer osim udobnog sedenja, treba biti i ukras prostora. Ova stolica je presvučena štoфом visokog kvaliteta, sa nogama izrađenim od bukovog drveta.

Dining chair Jelena has a significant role in kitchen arrangement, because apart from comfortable seating it should be room decoration. This chair is coated with a high quality cloth, with legs made of beech wood.



**Belo**  
White

**Hrast**  
Oak

**Wenge**  
Wenge

○ ID MITA169

● ID MITA170

● ID MITA168



# Stolice Palma

Trpezarijske stolice / Dining Chairs  
dimenzija/dimension: 100 x 48 x 46 cm



Dezeni / Colors



**Trešnja**  
Cherry

**Wenge**  
Wenge

**Natur**  
Natur

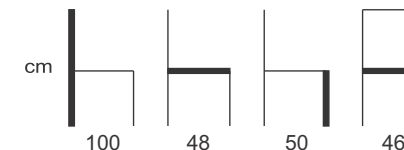

ID PR73092

Palma natur/malteze  
Palma natur/malteze



ID PR73093

Palma trešnja/malteze  
Palma cherry/malteze



ID PR73072

Palma wenge/malteze  
Palma wenge/malteze



ID PR73071

Palma natur/bež  
Palma natur/beige



ID PR73091

Palma trešnja/bež  
Palma cherry/beige



ID PR73090

Palma wenge/bež  
Palma wenge/beige



# PREDSOBLJA

*Hall units*

## **Predsoblja Matis**

Funkcionalna, jednostavna za montažu, sa frontovima izrađenim od medijapana (MDF) ili univera u softforming obradi. Pojedinačni, međusobno kompatibilni elementi, izrađeni u više dezena, omogućavaju veliki broj kombinacija za uređenje Vašeg doma. Izaberite kombinaciju pojedinačnih elemenata sa odgovarajućim cipelarima i komodama i učinite prijatnu dobrodošlicu u Vaš dom.

## **Matis Hall Units**

*Functional, easy to install, with fronts made of MDF or chipboard in softforming. Individual, mutually compatible elements, made in several patterns, allow a large number of combinations to decorate your home. Choose a combination of individual elements with appropriate shoe cabinets and chests and make a warm welcome to Your home.*



# MDF PREDSOBLJA

frontovi od medijapana

## MDF HALL UNITS

fronts of mediapan



Hrast/bež sjaj  
Oak/Beige gloss



Tobako/belo sjaj  
Tobacco/white gloss

**NAPOMENA:**  
Sva vrata su pripremljena  
za levo i desno otvaranje.  
**NOTE:**  
All doors are ready for  
left and right opening.

Vešalica / Hanger



Korpus/Corps



Lice/Front

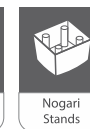

### Apolon PA 1 MDF

50x37x209 cm

ID 100133  
Hrast/bež sjaj  
Oak/beige gloss

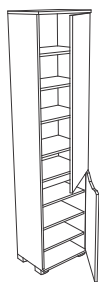

### Apolon PA 1 O MDF

50x37x209 cm

ID 101033  
Hrast/bež sjaj  
Oak/beige gloss

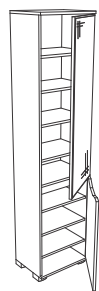

### Apolon PA 2 MDF

50x37x209 cm

ID 100233  
Hrast/bež sjaj  
Oak/beige gloss

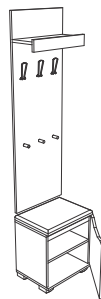

### Apolon PA 3 MDF

50x113 cm  
ogledalo

ID 100433  
Hrast/bež sjaj  
Oak/beige gloss

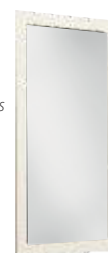

### Apolon PA-3

50x37x95 cm  
komoda  
cupboard

ID 100333  
Hrast/bež sjaj  
Oak/beige gloss



### Apolon PA 5 MDF

50x22x114 cm

ID 100833  
Hrast/bež sjaj  
Oak/beige gloss

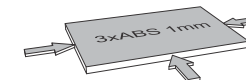
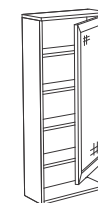

### Apolon PA 6 MDF

25x37x209 cm

ID 100933  
Hrast/bež sjaj  
Oak/beige gloss



### Apolon PA 1 MDF

50x37x209 cm

ID 102114  
Tobako/belo sjaj  
Tobacco/white gloss

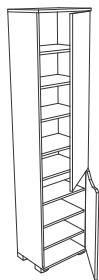

### Apolon Pa1 O MDF

50x37x209 cm

ID 102214  
Tobako/belo sjaj  
Tobacco/white gloss

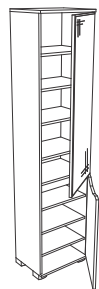

### Apolon PA 2 MDF

50x37x209 cm

ID 102314  
Tobako/belo sjaj  
Tobacco/white gloss

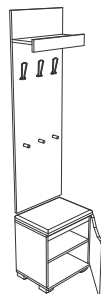

### Apolon PA 3 MDF

50x113 cm  
ogledalo  
mirror

ID 100402  
Tobako/belo sjaj  
Tobacco/white gloss



### Apolon PA 3

50x37x95 cm  
komoda  
cupboard

ID 102414  
Tobako/belo sjaj  
Tobacco/white gloss



### Apolon PA 5 MDF

50x22x114 cm

ID 102514  
Tobako/  
belo sjaj  
Tobacco/  
white gloss

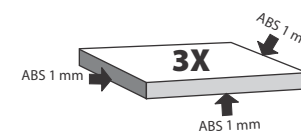
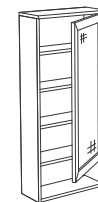

### Apolon PA 6 MDF

25x37x209 cm

ID 102614  
Tobako/  
belo sjaj  
Tobacco/  
white gloss

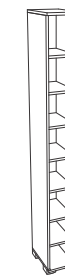



# APOLON PREDSOBLJA

frontovi od univera/softforming obrada



## APOLON HALL UNITS

fronts of chipboard/softforming

### PA 1

50 x 37 x 209 cm

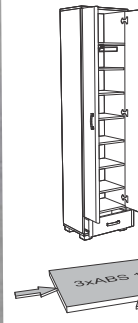

ID 100109  
belo / white

ID 100103  
trešnja / cherry

ID 100112  
hrast / oak

ID 100146  
snežni hrast / snow oak

ID 100152  
tobako / tobacco

### PA 2

50 x 37 x 209 cm



ID 100209  
belo / white

ID 100203  
trešnja / cherry

ID 100212  
hrast / oak

ID 100246  
snežni hrast / snow oak

ID 100252  
tobako / tobacco





<b>18 mm</b> Univer Chipboard	<b>M</b> Metal Ručica Handle	<b>30 mm</b> Zaobljenje Soft forming	 Nogari Stands	<b>ABS</b> <b>1 mm</b> Kant traka Edge Band	<b>ABS</b> <b>0,4 mm</b> Kant traka Edge Band	 Hanger Gard. šipka Hanger	 Soft forming Obrada / Finishing
-------------------------------------	---------------------------------------	--	----------------------	--	--	-------------------------------------	--

### PA 3 Ogledalo

50 x 113 cm

PA 3 mirror

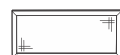

ID 100409  
belo / white



ID 100403  
trešnja / cherry



ID 100412  
hrast / oak



ID 100446  
snežni hrast / snow oak



ID 100452  
tabako / tobacco



### PA 3 komoda

50 x 37 x 95 cm

PA 3 cupboard

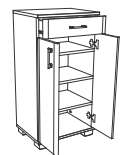

ID 100309  
belo / white



ID 100303  
trešnja / cherry



ID 100312  
hrast / oak



ID 100346  
snežni hrast / snow oak



ID 100352  
tobako / tobacco

### Apolon PA 5

Predsooblje "Apolon PA 5"

50 x 22 x 114 cm

Hall unit "Apolon PA 5"

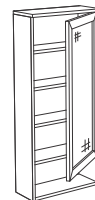

belo/white  
ID 100809



trešnja/cherry  
ID 100803



hrast/oak  
ID 100812



snežni hrast/snow oak  
ID 100846



tobako/tobacco  
ID 100852

# Atina

Predsoblje "Atina"  
Hall unit "Atina"

09

Belo  
White

03

Trešnja  
Cherry

12

Hrast  
Oak

46

Snežni hrast  
Snow oak

52

Tobako  
Tobacco

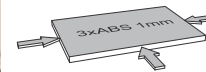

**A1**  
50x37x209 cm

**A2**  
50 x 209 cm



**ID 1101\*\***  
trešnja / cherry



**ID 1102\*\***  
trešnja / cherry



**ID 1101\*\***  
hrast / oak



**ID 1102\*\***  
hrast / oak



**ID 1101\*\***  
snežni hrast / snow oak



**ID 1102\*\***  
snežni hrast / snow oak



**ID 1101\*\***  
tobako / tobacco



**ID 1102\*\***  
tobako / tobacco

# Čiviluk Matis

Hanger "Matis"  
149 x 7 x 50 cm



ID 1006\*\*  
belo / white



ID 1006\*\*  
hrast / oak



ID 1006\*\*  
tobako / tobacco



ID 1006\*\*  
snežni hrast / snow oak

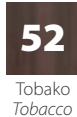

# Cipelari Shoe cabinets

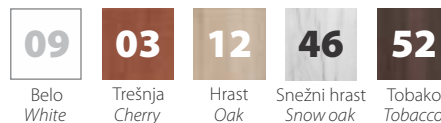

## Odisej 3V

Cipelar "Odisej 3V"  
70 x 28 x 120 cm  
Shoe cabinets "Odyssey 3V"

Spoljašnje ivice korpusa elemenata okantovane sa 1 mm ABS.  
*The outer edges of the corpus of the elements stained with 1 mm ABS.*

HAFELE  
MEHANIZAM



ID 1302\*\*  
belo / white



ID 1302\*\*  
hrast / oak



ID 1302\*\*  
trešnja / cherry



ID 1302\*\*  
snežni hrast / snow oak

## Odisej 4V

Cipelar "Odisej 4V"  
70 x 28 x 157 cm  
Shoe cabinets "Odyssey 4V"

Spoljašnje ivice korpusa elemenata okantovane sa 1 mm ABS.  
*The outer edges of the corpus of the elements stained with 1 mm ABS.*

HAFELE  
MEHANIZAM



ID 1303\*\*  
belo / white



ID 1303\*\*  
hrast / oak



ID 1303\*\*  
tobako / tobacco



ID 1303\*\*  
snežni hrast / snow oak

## Odisej 3V MDF

Cipelar "Odisej 3V MDF"  
70 x 28 x 120 cm  
Shoe cabinets "Odyssey 3V MDF"



Hrast/bež sjaj  
Oak/beige gloss



Tobako/belo sjaj  
Tobacco/white gloss

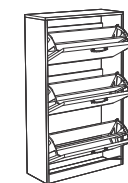

ID 1302\*\*  
tobako/belo sjaj  
tobacco/white gloss

## Odisej 4V MDF

Cipelar "Odisej 4V"  
70 x 28 x 157 cm  
Shoe cabinets "Odyssey 4V MDF"



Hrast/bež sjaj  
Oak/beige gloss



Tobako/belo sjaj  
Tobacco/white gloss



ID 1303\*\*  
hrast/ bež sjaj  
oak/beige gloss



# TV KOMODE

*TV stands*

Od pojave LCD televizora, teško je zamisliti dnevni boravak bez TV komode. TV komode su prilagođene specifičnim dimenzijama u kojima se izrađuju moderni televizori i pružaju savršen oslonac ovoj osjetljivoj tehnologiji. Pored svoje osnovne upotrebe, TV komode su praktične i za odlaganje velikog broja predmeta koje želite da držite nadohvat ruke u dnevnom boravku.

*Since the emergence of an LCD TV, it's hard to imagine a living room without a TV stand. TV stands are adapted to the specific dimensions in which modern TVs are made and provide the perfect support for this delicate technology. In addition to its basic use, TV stands are also convenient for storing a large number of items that you want to keep at your fingertips in the living room.*



# Luna

TV komoda "Luna"  
135 x 50 x 67,5 cm  
TV stand "Luna"



<b>18 mm</b> Univer Chipboard	<b>25 mm</b> Univer Chipboard	<b>M Metal</b> Ručica Handle	<b>30 mm</b> Zaobljenje Soft forming	Nogari Stands	<b>ABS</b> <b>0,4 mm</b> Kant traka Edge Band	<b>ABS</b> <b>1 mm</b> Kant traka Edge Band	<b>ABS</b> <b>2 mm</b> Kant traka Edge Band	<b>AL Aluminium</b> Distanceri Spacers
----------------------------------	----------------------------------	---------------------------------	---	---------------	---	---	---	---



ID 200103  
trešnja / cherry



ID 200113  
hrast / oak



ID 200146  
snežni hrast / snow oak

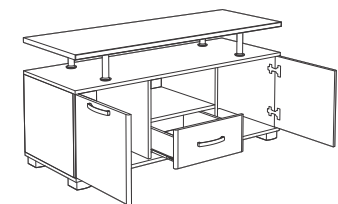

ID 200152  
tobako / tobacco



# KOMODE

## *Cupboards*

Komode su višenamenski komadi nameštaja čiju upotrebu možete beskrajno prilagođavati sopstvenim idejama i potrebama. Bilo da se radi o klasičnim fiokarima, komodama sa policama, ugaonim komodama ili komodama za LCD TV, u pitanju je komad nameštaja koji je pogodan za korišćenje u spavaćim i dnevnim sobama, predsobljima, pa čak i u ostavama.

*Cupboards are multipurpose furniture pieces which use can be adjusted to your own ideas and needs. Whether it's classic trolleys, shelves with shelves, angular chambers or LCD TVs, it's a piece of furniture that is suitable for use in bedrooms and living rooms, anteroom and even in pantries.*

## Roma 150

Komoda "Roma 150"  
149,6 x 40 x 80 cm  
Cupboard "Roma 150"

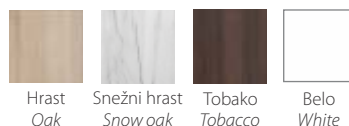

ID 141209  
belo / white



ID J141233  
hrast / oak



ID J141246  
snežni hrast / snow oak

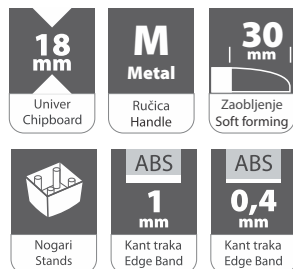

ID 141252  
tobako / tobacco

**Niša / Open box**  
šampanj / champagne  
ID 141340

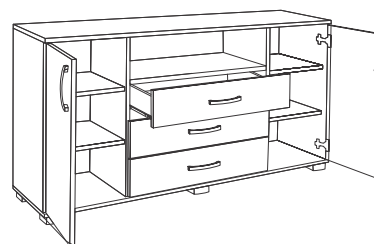

**Niša / Open box**  
antracit / antracit  
ID 141352

## Roma 1

Komoda "Roma 1"  
75 x 37 x 95 cm  
Cupboard "Roma 1"



ID 140109  
belo / white



ID 140152  
tobako / tobacco

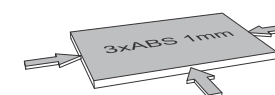
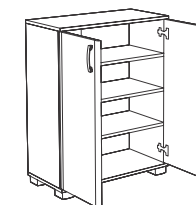

**TROSTRANO OKANTOVANI PODOVI I PLAFONI**  
Three side edge banding of floors and ceiling



ID 140103  
trešnja / cherry



ID 140146  
snežni hrast / snow oak



ID 140112  
hrast / oak

## Roma 1 MDF

Frontovi od medijapana  
Fronts of mediapan

Komoda "Roma 1 MDF"  
75 x 37 x 95 cm  
Cupboard "Roma 1 MDF"



Hrast/bež sjaj  
Oak/beige gloss



Tobako/belo sjaj  
Tobacco/white gloss

ID 140133  
hrast/bež sjaj  
oak/beige gloss



ID 140114  
tobako/belo sjaj  
tobacco/white gloss





## Roma 3

Komoda "Roma 3"  
112,5 x 37 x 95 cm  
Cupboard "Roma 3"

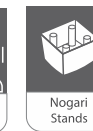
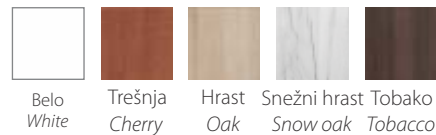

ID 140309  
belo / white



ID 140352  
tobako / tobacco



ID 140303  
trešnja / cherry



ID 140312  
hrast / oak



ID 140346  
snežni hrast / snow oak

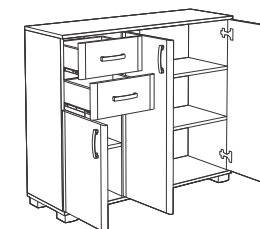

## Roma 3 MDF

Frontovi od medijapana  
Fronts of mediapan

Komoda "Roma 3 MDF"  
112,5 x 37 x 95 cm  
Cupboard "Roma 3 MDF"



Hrast/bež sjaj  
Oak/beige gloss



Tobako/belo sjaj  
Tobacco/white gloss

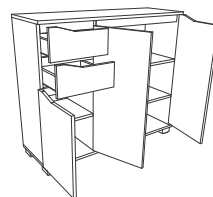

ID 140333  
hrast/ bež sjaj  
oak/beige gloss



ID 140314  
tobako/belo sjaj  
tobacco/white gloss



## Roma 4

Komoda "Roma 4"  
75 x 52 x 80 cm  
Cupboard "Roma 4"

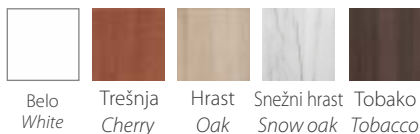

## Roma 7

Komoda "Roma 7"  
45 x 52 x 100 cm  
Cupboard "Roma 7"

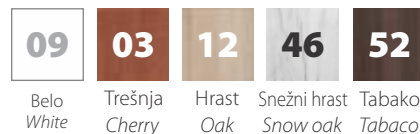

## Roma RU

Komoda "Roma RU"  
72/37 x 72/37 x 95 cm  
Cupboard "Roma RU"

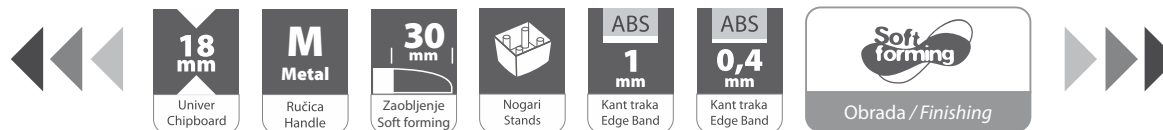
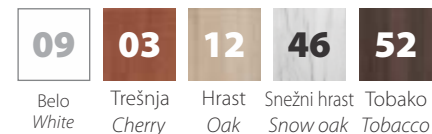

ID 140409  
belo / white



ID 140403  
trešnja / cherry



ID 140512  
hrast / oak



ID 140446  
snežni hrast / snow oak



ID 140452  
tobako / tobacco

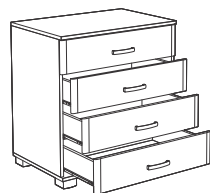

ID 1408\*\*  
snežni hrast / snow oak



ID 1408\*\*  
trešnja / cherry



ID 1408\*\*  
tobako / tobacco

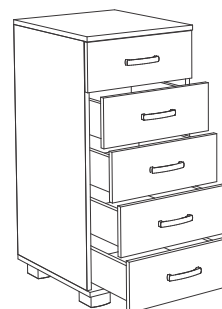

ID J1407\*\*  
hrast / oak



ID J1407\*\*  
trešnja / cherry



ID J1407\*\*  
tobako / tobacco



ID J1407\*\*  
snežni hrast / snow oak

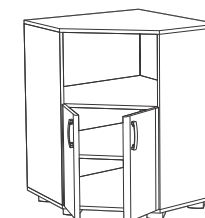



# KLUB STOLOVI

*Club tables*

Klub stolove od univera odlikuje jednostavnost, prefinjenost i funkcionalnost. Klub sto se zbog svog savremenog dizajna može prilagoditi različitim prostorima, a može koristiti, pored vašeg doma, i u kancelarijama i ostalim poslovnim objektima. Idealno mesto za odlaganje knjiga, časopisa i posluživanje poslastica za vaše prijatelje.

*Club tables made of chipboard are distinguished by simplicity, sophistication and functionality. A club table, because of its modern design, can be adapted to different spaces, and can be used, aside from your home, in offices and other business facilities. An ideal place for storing books, magazines and serving delicacies for your friends.*

## Oskar

Klub sto "Oskar"  
102 x 51 x 51 cm  
Club table "Oscar"



ID 2101\*\*  
trešnja / cherry



ID 2101\*\*  
tobako / tobacco



ID 2101\*\*  
snežni hrast / snow oak

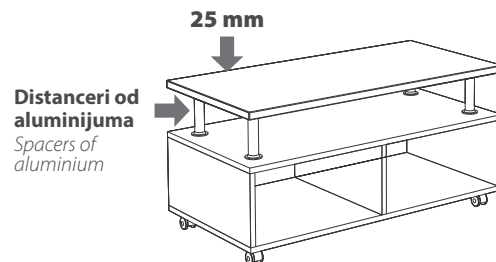

## Hermes

Klub sto "Hermes"  
90 x 50 x 50 cm  
Club table "Hermes"

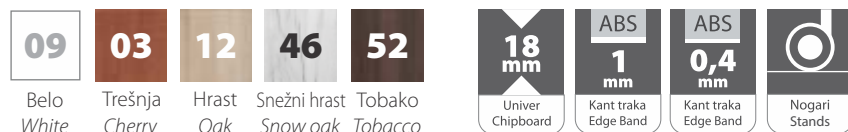

ID J2106\*\*  
hrast / oak



ID J2106\*\*  
tobako / tobacco



ID J2106\*\*  
snežni hrast / snow oak

## Monika

Ogledalo "Monika"  
65 x 70 cm  
Mirror "Monica"

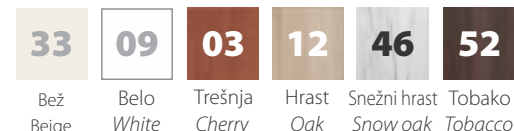

ID 3630\*\*  
bež sraj / beige gloss



ID 3630\*\*  
tobako / tobacco



ID 3630\*\*  
snežni hrast / snow oak

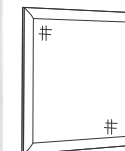

## Pikolo

Klub set "Pikolo"  
45 x 38 48 cm  
Club set "Piccolo"

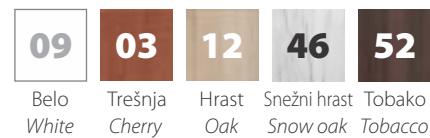

ID 2105\*\*  
snežni hrast / snow oak



ID 2105\*\*  
trešnja / cherry



ID 2105\*\*  
tobako / tobacco

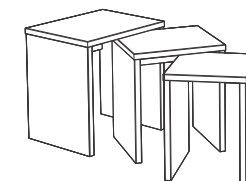

# DNEVNE SOBE

## *Living rooms*

Dizajnerski tim kompanije Matis sa ponosom predstavlja dnevne sobe od medijapana (MDF-a). Upotreba medijapana u izradi nameštaja za dnevne sobe omogućava proizvodnju komada nameštaja visokog nivoa estetike, po veoma pristupačnoj ceni.

*Matis design team is proud to present Mediapan (MDF) living room. The use of mediapan in making furniture pieces for living rooms allows production of furniture pieces at high level of aesthetic, at an affordable price.*



# VENETO

VENETO

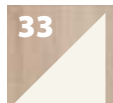

Hrast/bež sjaj  
Oak/beige gloss



Tobako/belo sjaj  
Tobacco/white gloss

Front: **MEDIJAPAN (MDF)**

Korpus: **UNIVER**

Front: **MEDIAPAN (MDF)**

Corps: **CHIPBOARD**



**Vitrina W55/S / Showcase W55/S**  
55 x 43 x 196 cm  
ID 5705\*\*



**Zidna polica / Wall shelf**  
102 x 64 x 47 cm  
ID 5706\*\*



**Klub sto / Club table**  
102 x 64 x 47 cm  
ID 5701\*\*



**Komoda V160 / Cupboard V160**  
160 x 43 x 90 cm  
ID 5702\*\*

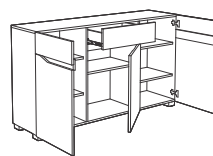

**Komoda V85 / Cupboard V85**  
85 x 43 x 90 cm  
ID 5703\*\*

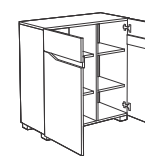

**TV komoda / TV stand**  
160 x 47 x 43 cm  
ID 5704\*\*

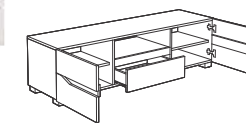

# WOOD

WOOD

# DNEVNE SOBE

Living rooms



Veoma nam je bitno da nameštaj u dnevnom boravku, prostoriji u kojoj primamo goste i organizujemo porodična okupljanja, osim funkcionalne, sadrži i visoku estetsku vrednost. Primena univera u izradi nameštaja za dnevne sobe omogućila nam je da na efikasan način na tržište donesemo elegantne i pristupačne dnevne sobe od univera, ne gubeći pritom na kvalitetu, TV komode, ormari, klub stolovi i police vrhunskog dizajna, nikada nisu bili pristupačniji.

*It is important for us that furniture in the living room, the room where we receive guests and organize family gatherings, apart from the functional, also contains a high aesthetic value. The application of the chipboard in furniture production for living rooms has enabled us to bring elegant and affordable living rooms made of chipboard without losing in quality. TV stands, wardrobes, club tables and top designed shelves have never been more accessible.*





# WOOD WHITE

WOOD WHITE



## WOOD

WOOD

41

09

San remo / late  
San remo / late

Belo / White  
San remo / late

**NAPOMENA:** Kompletna šifra elementa se dobija zamenom zvezdica \*\* sa dve cifre iz prikazanih dezena.

**NOTE:** The complete code of an element is obtained by replacing stars\*\* with two digits of the displayed pattern.

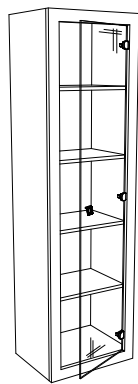

**Vitrina W55/S**  
Showcase W55/S  
55 x 42,5 x 195 cm  
ID 5506\*\*

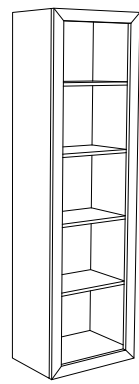

**Vitrina W55**  
Showcase W55/S  
55 x 42,5 x 195 cm  
ID 5505\*\*

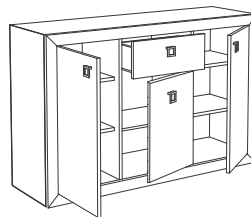

**Komoda W140**  
Cupboard W140  
140 x 42,5 x 90 cm  
ID 5503\*\*



**Komoda W85**  
Cupboard W85  
85 x 42,5 x 90 cm  
ID 5502\*\*

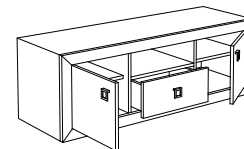

**TV komoda / TV stand**  
140 x 47,5 x 47 cm  
ID 5507\*\*

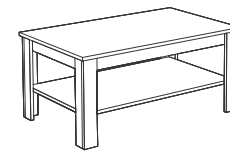

**Klub sto / Club stand**  
92 x 60 x 47 cm  
belo/white ID 550109  
snežni hrast/snow oak ID 550841



**Zidna polica / Wall shelf**  
1307140 x 24 x 23 cm  
ID 5504\*\*



# DNEVNE SOBE

## *Living rooms*

Gotova rešenja za dnevne sobe konstruisali su naši dizajneri, pred kojima je bio postavljen zadatak da pronađu kombinaciju elemenata koji će u jednom bloku obuhvatiti sav nameštaj potreban prosečnom korisniku. Prednost kupovine gotovih rešenja dnevnih soba je svakako u njihovoj funkcionalnosti, uniformnom izgledu i veoma povoljnoj ceni.

*Ready - made solutions for living rooms were designed by our designers, who were tasked to find a combination of elements that will encompass all the furniture needed for an average user in one block. The advantage of buying ready-made living room solutions is certainly in their functionality, uniform appearance and very affordable price.*



# SIGMA

## SIGMA

Regal "Sigma"  
225 x 40 x 199 cm  
Cupboard "Sigma"



Hrast/šampanj  
Oak/champagne  
ID 230150



Snežni hrast/antracit  
Snow oak/antracit  
ID 230146

<b>18 mm</b> Univer Chipboard	<b>ABS</b> <b>1 mm</b> Kant traka Edge Band	<b>ABS</b> <b>0,4 mm</b> Kant traka Edge Band	<b>M</b> Metal Ručica Handle
-------------------------------------	--	--	---------------------------------------

## Klub sto Sigma

Club table Sigma  
102 x 64 x 47 cm



Snežni hrast / Snow oak  
ID 552146

Hrast / Oak  
ID 552112

SIGMA Dnevne sobe kombinacijom materijala i savremenih tehnologija obezbeđuju veoma dug vek trajanja. Izrađene su od oplemenjenog univera debljine 25mm i 18mm sa kvalitetnim ručkama i odstojnicima od aluminijuma. Dnevne sobe Sigma lako se mogu prilagoditi vašim potrebama i zahtevima prostora. Prednost ovih dnevnih soba je ta što se niti jedan element ne kači na vaš zid, tako da je lako prenosiv prilikom rekonstrukcije vašeg dnevnog boravka.

SIGMA Living Rooms by a combination of materials and modern technologies provide a very long life. They are made of 25 mm and 18 mm thick refined chipboard with quality handles and spacers made of aluminum. Sigma living rooms can easily be adapted to your needs and space requirements. The advantage of these living rooms is that no element is attached to your wall, so it is easily portable when reconstructing your living room.

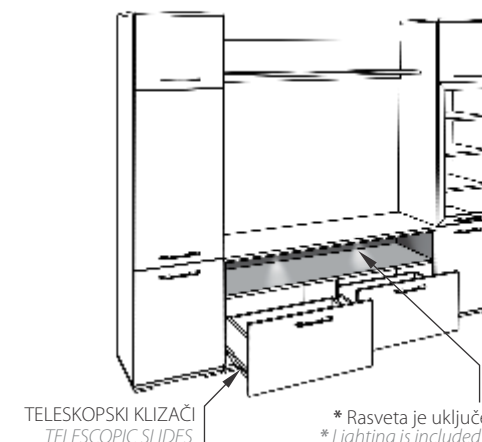

TELESKOPSKI KLIZAČI  
TELESCOPIC SLIDES

\* Rasveta je uključena u cenu  
\* Lighting is included in the price

quadro  
quadro



# QUADRO

## QUADRO

"Quadro"  
Zlatni hrast - belo sjaj  
*Living room "Quadro"  
golden oak-white gloss*

Korpus / Corps



Belo sjaj  
White gloss

Lice / Front



36  
Zlatni hrast  
Golden oak



09  
Belo sjaj  
White gloss



### Quadro

Minimalistički koncept i svedene forme Quadro programa sa jedne strane i raznolikost i toplina dekora frontova sa druge strane, doprinose uklapanju Quadro dnevnih soba, kako u savremene, tako i u klasične enterijere.

### Quadro

*Minimalistic concept and reduced forms of Quadro program, on the one hand, and variety and warmth of front decors on the other hand, contribute to matching of Quadro living rooms both in modern and in classical interiors.*

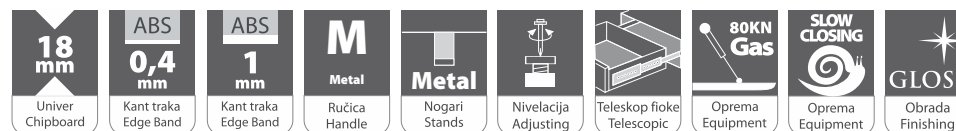



# QUADRO

## QUADRO

"Quadro"  
Zlatni hrast - belo sjaj  
*Living room "Quadro"*  
*golden oak-white gloss*

Korpus / Corps



Belo sjaj  
White gloss

Lice / Front



36  
Zlatni hrast  
Golden oak



09  
Belo sjaj  
White gloss



**Quadro OV1F**  
*Quadro OV1F*  
100 x 50 x 196 cm  
ID 5403\*\*

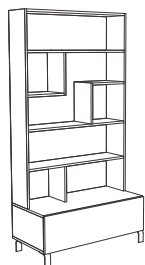

**Staklena vitrina Quadro**  
*Showcase Quadro*  
50 x 27 x 196 cm  
ID 5402\*\*

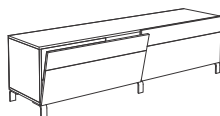
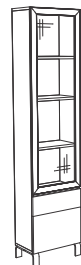

**Quadro TV komoda**  
*TV stand Quadro*  
200 x 50 x 55 cm  
ID 5401\*\*



**Quadro TV komoda 1F**  
*TV stand Quadro 1F*  
100 x 50 x 40 cm  
ID 5406\*\*

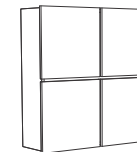

**Quadro 4V / Quadro 4V**  
94 x 27 x 94 cm  
ID 5404\*\*



**Quadro polica / Wall shelf**  
107 x 24 x 23 cm  
ID 5405\*\*

# DNEVNE SOBE

*Living rooms*



# MILANO

## MILANO

Dnevna i spavaća  
soba "Milano"  
*Living room and  
bedroom "Milano"*

Korpus / Lice  
Corps / Front

12

03

52

Hrast / Oak

Trešnja / Cherry

Tabako / Tabaco

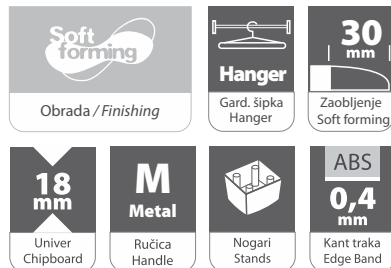

## Milano

Novi koncept soft obrade popularnog programa Milano sa ugaonim elementom i redizajniranom staklenom vitrinom, pruža mogućnost kombinovanja elemenata kako u spavaću sobu tako i u dnevni boravak prijatnog izgleda.

## Milano

*The new concept of soft processing of the popular Milano program, with a corner element and redesigned glass showcase, gives the possibility of combining elements both in the bedroom and in the living room, so pleasant looking.*

- Milano staklena vitrina / Milano glass showcase ①
- Milano POL 135 / Milano shelf POL 135 ②
- Milano POL 90 / / Milano shelf POL 90 ③
- Milano garderobier 2K2F / Milano wardrobe 2K2F ④
- TV komoda "Luna" / TV stand "Luna" ⑤

# MILANO

Dnevne i spavaće sobe

*Living room & bedroom Milano*





## Dnevne i spavaće sobe "Milano" Living rooms & bedrooms Milano

- 1 Ugaona garnitura "Nina" / Corner sofa "Nina"
- 2 Klub sto "Oskar" / Club table "Oscar"
- 3 Milano staklena vitrina / Milano glass showcase
- 4 Milano POL 90 / Milano shelf POL 90
- 5 Milano POL 135 / Milano shelf POL 135
- 6 TV komoda "Luna" / TV stand "Luna"
- 7 Milano garderobier 2K / Milano wardrobe 2K
- 8 Milano ugaoni ormar / Milano corner closet
- 9 Milano garderobier 1K1P / Milano wardrobe 1K1P



**Milano POL 90**  
87 x 20 x 2,5 cm  
ID 2709\*\*



**Milano POL 135**  
135 x 20 x 2,5 cm  
ID 2710\*\*



**NAPOMENA** Kompletna šifra elementa se dobija zamenom zvezdica \*\* sa dve cifre iz prikazanih dezena.  
**NOTE:** The complete code of an element is obtained by replacing stars\*\* with two digits of the displayed pattern.

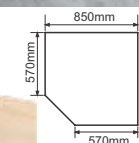

**Milano**  
garderobier 1K1P  
bez ogledala  
40 x 57 x 205 cm  
ID 2705\*\*



**Milano**  
garderobier 1K1P  
sa ogledalom  
40 x 57 x 205 cm  
ID 2704\*\*



**Milano**  
garderobier 2K  
80 x 57 x 205 cm  
ID 2701\*\*



**Milano**  
garderobier 2K2F  
80 x 57 x 205 cm  
ID 2706\*\*



**Milano**  
staklena vitrina  
80 x 47 x 205 cm  
ID 2703\*\*



**Milano**  
ugaoni ormar  
85/57 x 85/57 x 205 cm  
ID 2708\*\*



**Milano**  
garderobier 3K3F  
129 x 57 x 205  
ID 2707\*\*



# SPAVAĆE SOBE

## BEDROOMS

Svaku prostoriju u stanu možete urediti po vašoj zamisli, ne robujući nikakvim strogo nametnutim pravilima. Ovo naročito važi za spavaću sobu koja treba potpuno da se prilagodi vašim potrebama i shvatanju lepog. Sa druge strane, postoje neke smernice ukoliko želite da sobu uredite u nekom od najčešće korišćenih stilova. U okviru tih smernica, možete slobodno eksperimentisati, ali njih treba imati na umu kao olakšicu u traženju pravog rešenja.

*You can arrange every room in the apartment according to your idea, not be guided by strictly imposed rules. This is especially true for a bedroom that needs to be fully adapted to your needs and understanding of beauty. On the other hand, there are some guidelines if you want to arrange room in one of the most common used styles. Within these guidelines, you can freely experiment, but they should be kept in mind as a relief in finding the right solution.*



① Happy NORM / Happy NORM

② Bračni krevet "Woody CLASSIC" / Double bed "Woody Classic"

③ Happy KOM 3F / Happy KOM 3F

④ Happy ormar O2V / Happy wardrobe O2V

⑤ Happy ormar O2V2F / Happy wardrobe O2V2F



① Happy NORM / Happy NORM

② Bračni krevet "Šampanj" / Double bed "Champagne"

③ Happy KOM 3F / Happy KOM 3F

④ Happy ormar O3V2F / Happy wardrobe O3V2F

⑤ Happy ormar O2V2F / Happy wardrobe O2V2F



- 1 Ogledalo "Monika" / Mirror "Monica"
- 2 Komoda "Roma 4" / Cupboard "Roma 4"
- 3 Noćni ormarić "Alfa" / Night stand "Alfa"
- 4 Bračni krevet "Šampanj" / Double bed "Champagne"
- 5 Garderoba GD 240 / Wardrobe GD 240



- ① Ogledalo "Monika" / Mirror "Monica"
- ② Komoda "Roma 4" / Cupboard "Roma 4"
- ③ Noćni ormarić "Alfa" / Night stand "Alfa"

- ④ Bračni krevet "Woody CLASSIC" / Double bed "Woody Classic"
- ⑤ Garderoba GD 240 / Wardrobe GD 240



- ① Noćni ormarić "Matis 2F" / Night stand "Matis 2F"
- ② Bračni krevet "Woody SOFT" / Double bed "Woody"
- ③ Američki plakar 200 / American sliding wardrobe 200



- ① Noćni ormarić "Matis 2F" / Night stand "Matis 2F"
- ② Bračni krevet "Woody BOX" / Double bed "Woody Box"
- ③ Fortuna F1 / Wardrobe Fortuna F1
- ④ Fortuna F75 / Wardrobe Fortuna F75
- ⑤ Fortuna F2 POL / Wardrobe Fortuna F2 POL





- 1 Noćni ormarić "Alfa" / Night stand "Alfa"
- 2 Bračni krevet "Šampanj" / Double bed "Champagne"
- 3 Fortuna F1 / Wardrobe Fortuna F1
- 4 Fortuna FU / Wardrobe Fortuna FU

- 5 Fortuna F 75 / Wardrobe Fortuna F 75
- 6 Ogledalo "Monika" / Mirror "Monica"
- 7 Komoda "Roma 4" / Cupboard "Roma 4"



- |   |  |   |                                     |
|---|--|---|-------------------------------------|
| 1 | Noćni ormarić "Alfa" / Night stand "Alfa"          | 5 | Fortuna F1 / Wardrobe Fortuna F1    |
| 2 | Bračni krevet "Intro New" / Double bed "Intro New" | 6 | Komoda "Roma 4" / Cupboard "Roma 4" |
| 3 | Fortuna F3 / Wardrobe Fortuna F3                   | 7 | Ogledalo "Monika" / Mirror "Monica" |
| 4 | Fortuna F75 / Wardrobe Fortuna F75                 |   |                                     |



- 1 Fortuna F3 / Wardrobe Fortuna F3
- 2 Fortuna FU / Wardrobe Fortuna FU
- 3 Fortuna F1 / Wardrobe Fortuna F1

- 4 Bračni krevet "Intro New" / Double bed "Intro New"
- 5 Noćni stočić "Matis 3F" / Night stand "Matis 3F"



- ① Noćni ormarić "Matis 2F" / Night stand "Matis 2F"
- ② Krevet samac "Woody BOX" / Single bed "Woody Box"
- ③ Ormar IVA 3K2F / Wardrobe IVA 3K2F



- 1 Noćni ormarić "Matis 2F" / Night stand "Matis 2F"
- 2 Bračni krevet "Intro New" / Double bed "IntroNew"
- 3 Ormar IVA 4K2FO / Wardrobe IVA 4K2FO
- 4 Komoda "Roma 150" / Cupboard "Roma 150"
- 5 Niša sa rasvetom (opciono) / Open box with lighting (optional)

Osnova kreveta je ojačana čeličnim nogarima. Soba projektovana da zadovolji funkcionalne i estetske zahteve. Kombinacija savremenih materijala i minimalističkog dizajna.

*The base of the bed is reinforced with steel legs. Room designed to meet functional and aesthetic requirements. A combination of contemporary materials and minimalist design.*



# VENETO

## VENETO

Bedrooms "Veneto"

Korpus / Lice  
Corps / Front



Hrast / Bež sjaj / Oak / Beige gloss  
Snežni hrast / Antracit / Snow oak / Antracit



# FURNIKA

Led rasveta je sastavni deo ormara  
Lighting is an integral part of the wardrobe

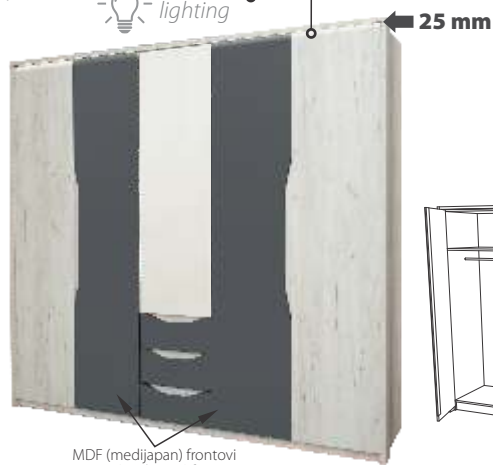

**Veneto ormar**  
Veneto wardrobe  
230 x 57,5 x 214,5 cm



hrast-bež sjaj / oak-beige gloss  
ID 590133  
snežni hrast-antracit / snow oak-antracit  
ID 590222



Fioka za odlaganje  
posteljine  
Bedding drawer

**Veneto bračni krevet**  
Veneto double bed  
Š x V x D 170 x 95 x 210,5 cm

Veneto krevet namenjen je za dušek 200x160 cm. Ima tapacirano uzglavlje, fioku na točkicama. Fioka se po potrebi može montirati sa leve ili desne strane.  
The Veneto bed is designed for a mattress of 200 x 160 cm. There is a upholstered headboard, a drawer with wheels. The drawer if it is necessary can be mounted on the left or the right.

U cenu je uključen pod kreveta od univera.  
Bed floor of chipboard is also included in the price.

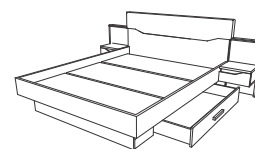

hrast-bež sjaj / oak-beige gloss  
ID 590333  
snežni hrast-antracit / snow oak-antracit  
ID 590422



**DESNI** hrast-bež sjaj / oak-beige gloss ID 590733  
**DESNI** snežni hrast-antracit / snow oak-antracit ID 590822  
**LEVI** hrast-bež sjaj / oak-beige gloss ID 590533  
**LEVI** snežni hrast-antracit / snow oak-antracit ID 590622

rasveta opciono  
lighting optional



rasveta opciono  
lighting optional



**Veneto noćni ormarić**  
Veneto night stand  
40,5x 34,5 x 72,5 cm

LED TRANSFORMATOR  
LED TRANSFORMER



ID 070110

LED PROFIL  
LED PROFILE



ID 070117

# GARDEROBERI

*Wardrobes*





# FORTUNA

## FORTUNA

Garderoberi "Fortuna soft"  
Wardrobe "Fortuna soft"

09

46

Belo / White

Snežni hrast / Snow oak

12

03

52

Hrast / Oak

Trešnja / Cherry

Tabako / Tabaco

Soft forming

Obrada / Finishing

Hanger

Gard. šipka  
Hanger

30 mm

Zaobljenje  
Soft forming

18 mm

Univer  
Chipboard

ABS

0,4 mm

Kant traka  
Edge Band

M

Metal

Ručica  
Handle

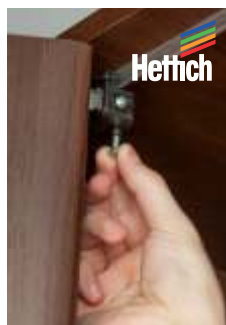

Hettich

### Novi mehanizam

Uveden je novi mehanizam od nemačkog proizvođača Hettich. Ovaj sistem znatno ubrzava montažu vrata jer se veći točkić samo jednim potezom pozicionira na šinu. Osim toga, bez ikakvog šrafljenja, prilikom ispadanja klizača iz šine, korisnik može sam da vrati klizač na postojeću šinu.



F1 • 50 x 52 x 222 cm  
ID 3040\*\*

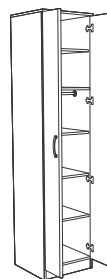

F1 • 50 x 52 x 222 cm  
ID 3040\*\*

F2 • 100 x 52 x 222 cm  
ID 3041\*\*

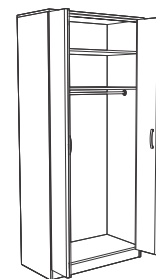

F2 • 100 x 52 x 222 cm  
ID 3041\*\*

F2 POL • 100 x 52 x 222 cm  
ID 3042\*\*

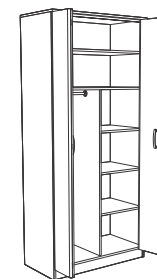

F2 POL • 100 x 52 x 222 cm  
ID 3042\*\*

F3 • 150 x 52 x 222 cm  
ID 3043\*\*

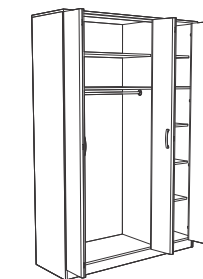

F3 • 150 x 52 x 222 cm  
ID 3043\*\*

F75 • 75 x 52 x 222 cm  
ID 3045\*\*

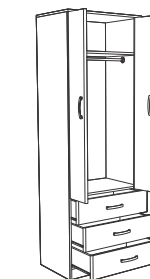

F75 • 75 x 52 x 222 cm  
ID 3045\*\*

FU • 88/52 x 87/52 x 222 cm  
ID 3046\*\*

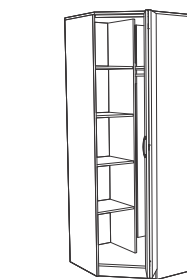

FU • 88/52 x 87/52 x 222 cm  
ID 3046\*\*

**NAPOMENA** Kompletna šifra elementa se dobija zamenom zvezdica \*\* sa dve cifre iz prikazanih dezena.

**NOTE:** The complete code of an element is obtained by replacing stars\*\* with two digits of the displayed pattern.

# GARDEROBERI

*Wardrobes*



# IVA IVA

Garderoberi "IVA"  
Wardrobe "IVA"

Korpus / Lice  
Corps / Front



Belo / White

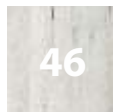

Snežni hrast  
Snow oak

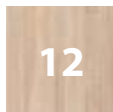

Hrast / Oak

Unutrašnjost  
Interior



za dezen belo  
for white color only



za dezen snežni hrast  
for snow oak color only



za dezen hrast  
for oak color only



## Ormar "Iva K2 POL 200"

82 x 53 x 200 cm  
Wardrobe "Iva K2 POL 200"

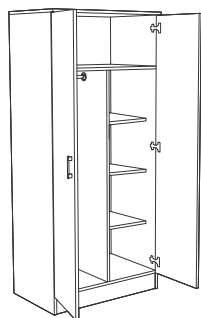

snežni hrast / snow oak  
ID 3113\*\*

## Ormar "Iva 3K2F"

123 x 53 x 200 cm  
Wardrobe "Iva 3K2F"

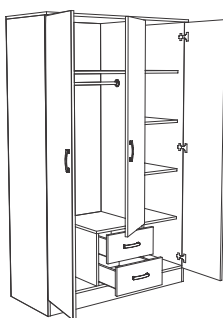

snežni hrast / snow oak  
ID 3111\*\*

## Ormar "Iva 3K2F O"

123 x 53 x 200 cm  
Wardrobe "Iva 3K2F O"

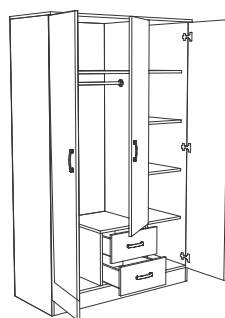

snežni hrast / snow oak  
ID 3112\*\*

## Ormar "Iva K3 "

123 x 53 x 200 cm  
Wardrobe "Iva K3"

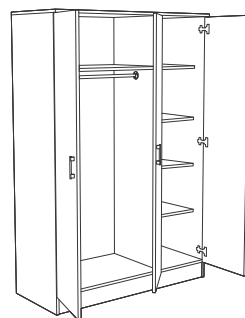

snežni hrast / snow oak  
ID 3114\*\*

## Ormar "Iva 4K2F "

123 x 53 x 200 cm  
Wardrobe "Iva 4K2F"

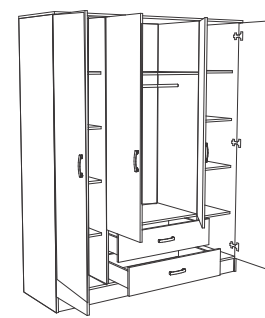

snežni hrast / snow oak  
ID 3116\*\*

## Ormar "Iva 4K2FO "

123 x 53 x 200 cm  
Wardrobe "Iva 4K2FO"

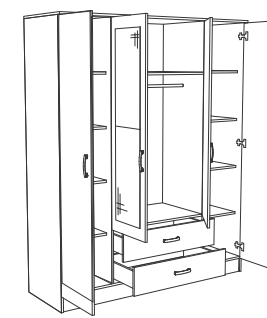

snežni hrast / snow oak  
ID 3117\*\*

# GARDEROBERI

*Wardrobes*



# VERONA 5KM

## VERONA 5KM

Garderobni ormar / Wardrobe  
dimenzija/dimension: 230 x 54 x 215 cm

Dezen / Color



Belo / Wenge  
White / Wenge

ID 521506

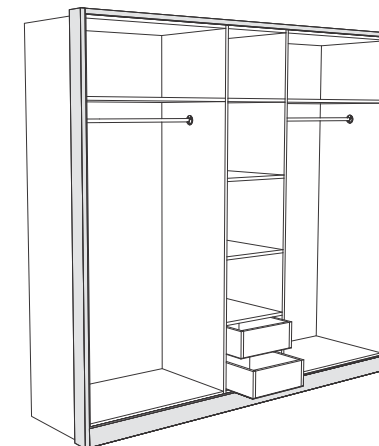

### VERONA 5KM ORMAR

Funkcionalnost i estetika

Na tržištu veoma popularan tradicionalni model ormara VERONA. Sada je modifikovan i dizajnerski prilagođen WOODY programu. Funkcionalan i prostran sa dodatne dve fiokke i ogledalom, odličan je izbor u opremanju spavaćih soba.

### VERONA 5KM WARDROBE

Functionality and aesthetics

Very popular and traditional model of wardrobe VERONA, has been modified and adapted to match WOODY program. Functional and spacious with additional two drawers and the mirror, represents an excellent choice in bedroom furnishing.



#### 1 NAPRAVLJEN DA TRAJE

Ojačanja od punog drveta

Kao i svi ormari iz WOODY programa ima ojačanja od punog drveta na svim ivicama. Donja sokla, koja je najčešće izložena oštećenjima, ojačana je lajsnom od punog drveta.

#### BUILT TO LAST

Solid wood reinforcement

Like all wardrobes in woody program this one also has the solid reinforcement of wood on all edges. Lower plinths which are usually exposed to damage have been reinforced by stripes made of solid wood.



#### 2 DODIR PRIRODE

Ručice od punog drveta

Inovativne ručice od punog drveta, u bojama dezena ormara, u kombinaciji sa aluminijumskim nosačem, izuzetan su dekorativni detalj. Svojom svedenom formom prate liniju ormara, a prirodan materijal drveta daje prijatan osećaj u ruci.

#### THE TOUCH OF NATURE

Solid wood handles

Innovative solid wood handles made in the same colors as wardrobes. The combination with an aluminium carrier is an outstanding decorative detail. With its reduced forms the handles follow the line of wardrobes, and wood as a natural material gives a pleasant feeling in the hand.



#### 3 NOVI DETALJI

Fiokke ormara

Za razliku od standardnog modela ormara VERONA, na ovom modelu su, na sugestiju kupaca, dodate dve fiokke. U kombinaciji sa ugrađenim ogledalom čine centralni detalj ormara.

#### NEW DETAILS

Wardrobe drawers

Unlike the standard model of wardrobe Verona, two drawers were added on this model at the suggestion of our customers. Combined with built-in mirror form the central detail of the wardrobe.



#### 4 LAGANO I PRAKTIČNO

LAGANA montaža

Ukrasni drveni profili su spojeni sa bočnim stranicama u procesu proizvodnje. Ovim načinom izrade dobijena je brža montaža ormara.

#### EASY AND CONVENIENT

Easy installation

Decorative wooden profiles are connected with the sides of the wardrobe in the production process. This way, the faster installation of the wardrobe has been achieved

# GD GARDEROBERI

*GD wardrobes*



# GARDEROBER

## GD 240

### WARDROBES GD 240

Garderobni ormar / Wardrobe  
dimenzija/dimension: 240 x 64 x 220 cm

Korpus / Lice  
Corps / Front



Arlington orah  
Sampanj  
Arlington walnut  
Champagne



Hrast-šampanj  
Oak-champagne



Snežni hrast-antrac.  
Snow oak-antracit



Belo-lila  
White-purple



Belo  
White



Belo-crno  
White-black



ID 521142  
arlington orah / arlington walnut



ID 521112  
hrast-šampanj / oak-champagne



ID 521146  
snežni hrast-antracit/ snow oak-antracit



ID 521109  
belo-lila / white-purple



ID 521114  
belo-belo / white-white



ID 521116  
belo-crno / white-black

Konstrukcija gornjeg klizača obezbeđuje sigurnost u eksploataciji da ne bi došlo do ispadanja frontova iz aluminijumskih vođica i dozvoljava eventualna odstupanja u horizontalnosti ormara do 8 mm.

The construction of the upper slide secures the usage, so it cannot happen for fronts (doors) to fall out from the aluminium leads and allows eventual horizontal deviations up to 8 mm.

**Aluminijumske vođice**  
Aluminium leads

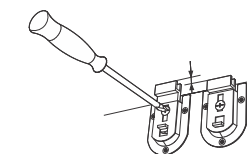
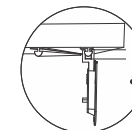
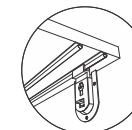

# GD GARDEROBERI

*GD wardrobes*





# GARDEROBER

## GD 180

### WARDROBES GD 180

Garderobni ormar / Wardrobe  
dimenzija/dimension: 180 x 64 x 220 cm

Korpus / Lice  
Corps / Front



Belo  
White



Hrast-šampanj  
Oak-champagne



Snežni hrast-antrac.  
Snow oak-antrac.



ID 521612  
hrast-šampanj/ oak-champagne



ID 521609  
belo-belo/ white-white

Garderoberi GD 180 pružaju dovoljno prostora za odlaganje sve vaše garderobe. Izrađeni su od oplemenjenog univera debljine 18 mm sa aluminijumskim vodičama i rukohvatima. Unutar garderobera pored poprečnih policica nalazi se i garderober šipka o koju možete kačiti kako džempere, jakne, košulje, tako i dugačke kapute i bunde. Garderober GD 180 odlikuje klasičan stil i elegancija u opremanju enterijera.

*Wardrobes GD 180 provide enough space to store all your clothes. They are made of a refined 18 mm thick chipboard with aluminium guides and handrails. Inside the wardrobe, except shelves, there is a hanger on which you can put jumpers, jackets, shirts and long coats and jackets. Wardrobe Gd180 characterizes classic style and elegance in interior design.*



ID 521646  
snežni hrast-antracit/ snow oak-antracit

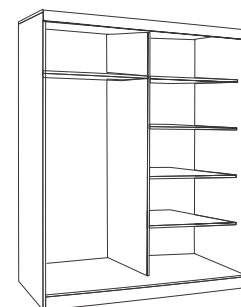

Aluminijumski rukohvat / Al handle



# GD GARDEROBERI

*GD wardrobes*



# GARDEROBER

## GD 150

### WARDROBES GD 150

Garderobni ormar / Wardrobe  
dimenzija/dimension: 150 x 64 x 220 cm

Korpus / Lice  
Corps / Front



Belo  
White



Hrast-šampanj  
Oak-champagne



Snežni hrast-antrac.  
Snow oak-antrac.



ID 524012  
hrast-šampanj/ oak-champagne



ID 524009  
belo-belo/ white-white

Klizni ormar GD 150 obećava enterijersku praktičnost i maksimalnu iskorišćenost prostora. Unutrašnji prostor ovog modela poseduje set polica i garderobnu šipku. Dubina ormara od 64 cm omogućava nesmetano odlaganje odeće bez gužvanja. Elementi ormara koji su izloženi habanju, a to su frontovi i bočne stranice, okantovani su ABS trakom debljine 1 mm.

*Sliding wardrobe GD 150 promises interior practicality and maximum space utilization. The interior space of this model has a set of shelves and clothes hanger. The depth of the wardrobe of 64 cm allows unhindered stacking of clothes. Elements of wardrobe that are exposed to damage, which are fronts and sides, are banded with an ABS stripe with thickness of 1 mm.*



ID 524046  
snežni hrast-antracit/ snow oak-antracit

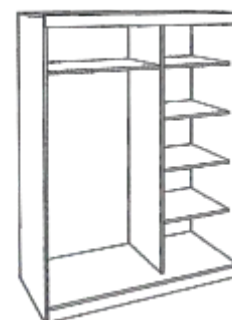

Aluminijumske vodice / Al trails



# GD GARDEROBERI

*GD wardrobes*



# GARDEROBER

## GD 120

### WARDROBES GD 120

Garderobni ormar / Wardrobe  
dimenzija/dimension: 120 x 64 x 220 cm

Korpus / Lice  
Corps / Front



Belo  
White



Hrast-šampanj  
Oak-champagne



Snežni hrast-antrac.  
Snow oak-antrac.



ID 523012  
hrast-šampanj/ oak-champagne



ID 523009  
belo-belo/ white-white

Garderoberi GD 120 pružaju dovoljno prostora za odlaganje vaše garderobe. Izrađeni su od oplemenjenog univera debljine 18 mm sa aluminijumskim vodičama i rukohvatima. Unutar garderobera pored poprečnih polica nalazi se i garderober šipka o koju možete kačiti kako džempere, jakne, košulje, tako i dugačke kapute i bunde. Garderobler GD 120 odlikuje klasičan stil i elegancija u opremanju enterijera.

*Wardrobes GD 120 provide enough space to store all your clothes. They are made of a refined 18 mm thick chipboard with aluminium guides and handrails. Inside the wardrobe, except shelves, there is a hanger on which you can put jumpers, jackets, shirts and long coats and jackets. Wardrobe GD 120 characterizes classic style and elegance in interior design.*



ID 523046  
snežni hrast-antracit/ snow oak-antracit

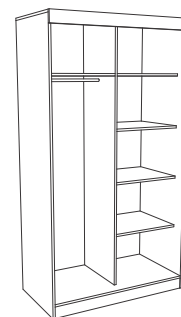

Aluminijumski rukohvat / Al handle



Aluminijumske vodice / Al trails



# AMERIČKI PLAKARI

*Sliding wardrobes*



# APM PLAKAR 280

## Wardrobe APM 280

dimenzija/dimension: 276 x 64 x 220 cm

Korpus / Lice  
Corps / Front



Hrast-šampanj Snežni hrast-antrac.  
Oak-champagne Snow oak-antrac.

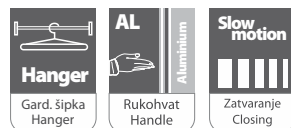
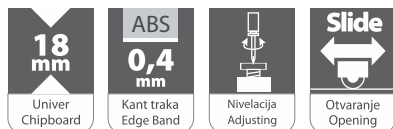

Američki plakar APM 280 projektovan je da svojim dizajnom i upotrebom prostorom donese maksimalnu organizaciju u ambijentu spavaće sobe. Raskošnih dimenzija i unutrašnjim rasporedom sa policama u središnjem delu i sa gaderobnim šipkama levo i desno pozicioniranim, zadovoljiće potrebe za odlaganjem garderobe. Dva dela američkog plakara sadrže garderober šipku, a jedan deo je podeljen policama za odlaganje garderobe. Izrađen je od oplemenjenog univera 18mm sa ramom od bukovog drveta koji daje dodatnu čvstinu.

*The Sliding Wardrobe APM 280 is designed to bring maximum organization in the ambience of bedroom with its design and usage space. The luxurious dimensions and internal shelf arrangement in the center and with hangers for clothes left and right positioned will satisfy need for stacking of clothes. Two parts of Sliding Wardrobe contains hanger for clothes, and one part is divided into shelves for stacking of clothes. It is made of 18 mm thick refined chipboard with beech wood frame that gives and extra strenght.*



ID 320740  
hrast-šampanj/ oak-champagne



ID 320746  
snežni hrast-antracit/snow oak-antracit



### 1 LAKA NIVELACIJA Nivelacija poda ormara na 6 nogara

Ispod poda ormara je ugrađeno 6 nogarića za lako besprekorno nivelisanje poda ormara. To je važno jer se u toku eksploatacije vrata veoma lako i beščujno otvaraju, a uz pomoć ugrađenog SlowMotion mehanizma, veoma lako i usporeno zatvaraju.

### EASY LEVELING Leveling the closet floor on 6 legs

*Bellow the floor of wardrobe there are 6 legs installed for easy leveling. This is important because during usage for doors are opening easy and silent, and with Slow Motion mechanism are very easy and slow closing.*

### 2 NOVI MEHANIZAM Bez problema i buke

Proizvođač mehanizma je unapredio sistem gornjih točkića. Umesto jednog većeg, sada postoje dva koja se rotiraju nezavisno jedan od drugog svaki na svoju površinu naleganja, pa u slučaju i da je šina malo deformisana, oni omogućavaju nesmetano kretanje vrata.

### NEW MECHANISM No problem - No noise

*The mechanism producer has improved the system of upper wheels. Instead of one big wheel there are now two wheels which rotate independetly from each other, so even there are small deformities of the leading line, they make possible the sliding of the doors.*

# AMERIČKI PLAKARI

*Sliding wardrobes*





# APM PLAKAR 200

Wardrobe APM 200

dimenzija/dimension: 203 x 67 x 220 cm

Korpus / Lice  
Corps / Front



Belo / Wenge  
White / Wenge

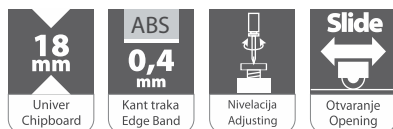

## APM 200 KLIZNI GARDEROBER Najbolje rešenje za garderobu

Jedan od najboljih garderobera na tržištu oplemenili smo elementima od punog bukovog drveta, posebno na ivicama koje su jako izložene habanju. Zbog kompatibilnosti sa ostalim nameštajem iz WOODY programa, klizna vrata su oplemenjena umetkom od obostrano furniranog medijapana.

## APM 200 SLIDING DOOR WARDROBE The best solution for the clothes

One of the best wardrobes in the market is enhanced with elements of beech wood, especially the edges that are exposed to wear. Because of compatibility with other furniture in WOODY program, the sliding doors are laminated with insertion which is both side veneered with MDF.



ID 320606  
belo-wenge / white-wenge

Vrata se dostavljaju namontirana  
Wardrobe doors are delivered assembled



## 1 BEZ BUKE Kvalitetne aluminijumske vodice

APM 200 ormari su opremljeni aluminijumskim šinama koje, u kombinaciji sa gumiranim točkicama, obezbeđuju klizanje vrata bez ikakve buke.

**NOISELESS**  
Quality aluminum guide rails

APM 200 wardrobes are equipped with aluminum guide rails that, combined with the rubber wheels make the sliding wardrobe doors noiseless.

## 2 LAGANO I PRAKTIČNO Lagana montaža

Ukrasni drveni profili su spojeni sa bočnim stranicama presovanjem i lepljenjem u procesu proizvodnje. Ovim se dobija jedinstvena celina bočne stranice i drvenog profila bez mogućnosti naknadnih deformacija. Ujedno je dobijena brza montaža ormara

**EASY AND CONVENIENT**  
Easy installation

Decorative wooden profiles are connected with the side walls by pressing and gluing in the production process. This provides a unity of side panels and wooden profiles without the possibility of subsequent deformation. Also, the faster installation of wardrobe is achieved.



## 3 LAKA NIVELACIJA Nivelacija poda ormara na 6 nogara

**3 LAKA NIVELACIJA**  
Nivelacija poda ormara na 6 nogara

**EASY LEVELING**  
Leveling the closet floor on 6 legs

# AMERIČKI PLAKARI

*Sliding wardrobes*



# AMERIČKI PLAKAR 200

## SLIDING WARDROBE 200

dimenzija/dimension: 200 x 65 x 220 cm

Korpus / Lice  
Corps / Front



Belo  
White



Hrast-šampanj  
Oak-champagne



Snežni hrast-antrac.  
Snow oak-antrac.



18 mm

Univer  
Chipboard



ABS  
0,4 mm

Kant traka  
Edge Band



Nivelacija  
Adjusting



Slide

Otvaranje  
Opening



Hanger

Gard. šipka  
Hanger



AL

Rukohvat  
Handle

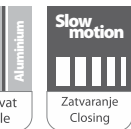

Slow motion

Zatvaranje  
Closing



ID 320240

hrast-šampanj/ oak-champagne



ID 320209

belo-belo/ white-white

Američki plakar AP 200 pravo je rešenje za postizanje enterijerske praktičnosti i maksimalne iskorišćenosti raspoloživog prostora. Unutrašnjost plakara je trodelna. Dva dela američkog plakara sadrže garderobier šipku i 2 fioke, a jedan deo je podeljen policama za odlaganje robe. Izrađen je od univera debljine 18 mm i poseduje soft-close mehanizam.

*Sliding wardrobe AP200 is right solution for achieving practicality and maximum utilization of available space. The interior of wardrobe contains three parts. Two parts of wardrobe contain hager for clothes and 2 drawers, and one part is divided by shelves for stacking of clothes. It is made of 18mm thick refined chipboard and has soft close mechanism.*

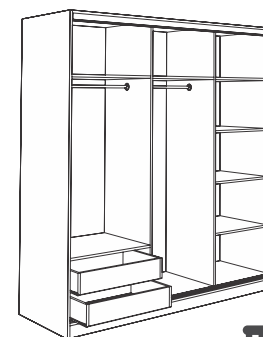

30x



ID 320246

snežni hrast-antracit/ snow oak-antracit



Točkići / wheels



Usporivač / Slow motion

# AMERIČKI PLAKARI

*Sliding wardrobes*



# AMERIČKI PLAKAR 150

## SLIDING WARDROBE 150

dimenzija/dimension: 148,5 x 65 x 220 cm

Korpus / Lice  
Corps / Front



Belo / White

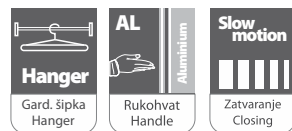
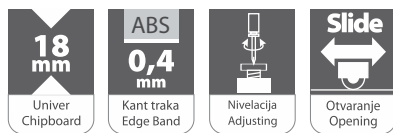

Izuzetno funkcionalni Američki plakari AP 150 modernog i praktičnog dizajna izrađeni od oplemenjenog univera debljine 18mm. Američki plakari su zbog svoje praktične upotrebe postali pravi hit u svetu, a i kod nas. Vrhunske izrade, sa kliznim vratima i ojačanim sistemom šina, usporivačima, skrivenim fiokama, policama i garderobnim delom, ovaj plakar predstavlja nepogrešiv izbor za vaš dom. Unutrašnjost američkog plakara je veoma prostrana i podeljena je policama.

*The highly functional American closets AP 150 are modern and practical design made from a refined 18mm thick university. Because of their practical use, American cabinets have become a real hit in the world, and even with us. Superb design, with sliding doors and a reinforced rail system, decelerators, hidden drawers, shelves and wardrobe, this closet is an unmistakable choice for your home. The interior of the American closet is very spacious and it is divided into shelves.*



ID 320109  
belo / white

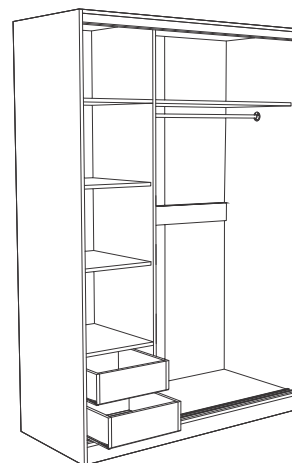

20x



### Podešavanje / Adjusting

#### LAKA NIVELACIJA Nivelacija poda ormara na 6 tačaka

Ispod poda ormara je ugrađeno 6 nogarića za lako besprekorno nivelisanje poda ormara. To je važno jer se u toku eksploatacije vrata veoma lako i beščujno otvaraju, a uz pomoć ugrađenog SlowMotion mehanizma, veoma lako i usporeno zatvaraju.

#### EASY LEVELING Leveling the closet floor on 6 points

*Bellow the floor of wardrobe there are 6 legs installed for easy leveling. This is important because during usage for doors are opening easy and silent, and with Slow Motion mechanism are very easy and slow closing.*



# NOĆNI ORMARIĆI

## *Nightstands*

Koliko ste samo puta ustajali noću i potpuno se razbudili da biste otišli po čašu vode. Sa noćnim ormarićima kompanije Matis, više nećete morati da ustajete iz tople postelje, jer će Vam sve potrebštine uvek biti lako dostupne. Noćni ormarići posebno su dragi ljubiteljima dobre knjige, ili onima koji ne mogu da zamisle ni trenutak bez mobilnog telefona nadohvat ruke.

*How many times did you get up and was totally awake to go for a glass of water? With Matis nightstands you will no longer have to get out of the warm bed, as all you need will be always easy to access. Nightstands are especially dear to people who love to read or to the ones that can not imagine a moment with out a mobile phone at their fingertips.*



# Matis 3F

Noćni ormarić "Matis 3F"  
49 x 38 x 65 cm  
Nightstand "Matis 3F"



ID 360309  
belo / white



ID 360352  
tabako / tobacco



ID 360346  
snežni hrast-antracit  
snow oak-antracit



ID 360512  
bardolino-hrast / bardolino-oak

# Matis 2F

Noćni ormarić "Matis 2F"  
49 x 38 x 45,5 cm  
Nightstand "Matis 2F"



ID 360209  
belo / white



ID 360212  
hrast / oak



ID 360203  
trešnja / cherry



ID F 360209



ID F 360212



ID F 360203

WOODY FRONTOM - Mogućnost doplate - Woody fronts - Optional



ID 360252  
tobako / tobacco



ID 360246  
snežni hrast-antracit  
snow oak-antracit

# Alfa

Noćni ormarić "Alfa"  
40 x 43 x 52 cm  
Nightstand "Alfa"

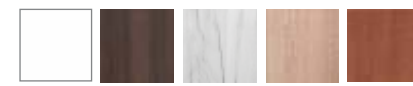

ID 360109  
belo / white



ID 360152  
tobako / tobacco



ID 360146  
snežni hrast / snow oak



ID 360312  
hrast / oak



ID 360103  
trešnja / cherry

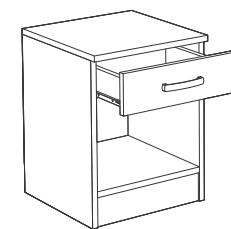
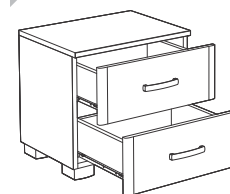
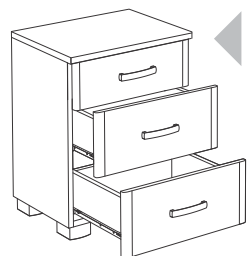



# WOODY KREVETI

WOODY BEDS

**Kreveti od punog drveta bukve**

*Solid wood beds*

Savremen način i ubrzan tempo života opterećen stresom, ostavlja nam sve manje vremena za odmor, što ozbiljno ugrožava naše zdravlje. Zdrav san i odmor postali su bitni faktori poboljšanja kvaliteta života.

Istovremeno, savremeni trendovi potrošačkog društva i sve veća potreba za dodatnim prostorom za odlaganje stvari, uslovljavaju da životno okruženje moramo opremiti maksimalno funkcionalno.

Dugogodišnjim iskustvom u proizvodnji nameštaja i osluškivanjem želja i potreba kupaca, pokušali smo da napravimo više modela kreveta visokog kvaliteta i estetike. Koliko smo u tome uspeli prosudite sami.

*Modern and fast way of life full of stress is leaving us with less time to rest, this can seriously threaten our health. Healthy sleep and rest have become important factors for improving the quality of life.*

*At the same time, current trends of the consumer society and the growing need for additional space to store things are forcing us to arrange our living space with maximum functionality.*

*Years of experience in the furniture production and listening to the wishes and needs of our customers, made us make more models of beds with high quality and aesthetics. Did we succeed? Please judge for yourself.*





## Opšte karakteristike Woody kreveta

### General characteristics of Woody beds



### Čvrsta VEZA

#### Metalni sistem spajanja stranica kreveta

Za razliku od sličnih proizvoda na tržištu, kod kojih se spajanje stranica kreveta vrši vijcima za drvo bez tiplova, naši kreveti imaju sigurne, posebno dizajnirane, skrivene metalne spojnice renomiranog italijanskog proizvođača, što uz drvene tiplove omogućava čvrst spoj i dugogodišnju stabilnost.



### Elastična i sigurna PODLOGA

#### Pod kreveta

Podloge od šperploče daju ravnu i stabilnu osnovu za dušek čime se obezbeđuje njegovo ravnomerno opterećenje. Time je omogućen zdrav i pravilan položaj kičmenog stuba i celog tela tokom odmora i sna. Razmaci između letvica omogućavaju dobru cirkulaciju vazduha oko duška i njegovo provetravanje.



### Siguran OSOLONAC

#### Savršena podloga za svaki dušek

Na srednju potpornu letvu kreveta, na koju su vezane letvice, montirana su dva nogara za podešavanje visine, tako da se vrlo jednostavno i lako može dobiti savršeno ravna podloga za dušek, bez obzira na eventualne nedostatke poda na kome se krevet nalazi.

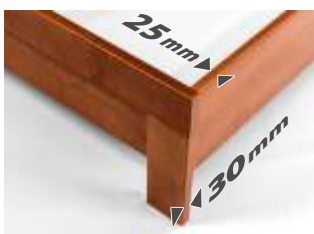

### Život sa PRIRODOM

#### Srednji metalni oslonac za potpornu gredu

Kreveti pravljani od punog bukovog drveta, osim što unose toplinu prirodnih materijala u vaš dom, postojani su i dugovečni. Bočne stranice izrađuju se od 25 mm, a čeonu stranu i nogari od 30 mm debljine drvenih ploča što daje posebnu stabilnost i čvrstinu.



### Ispod KREVETA

#### Lako dostupno i uvek čisto

Kako bi spavaća soba bila mesto zdravog odmora, veoma je važna mogućnost lakog čišćenja. Zato posebno ističemo da su svi WOODY kreveti nogarima odignuti od poda, koji je tako dostupan za održavanje.

### Strong CONNECTION

#### Metal system of bed side connecting

Unlike similar products on the market, where the connecting of the bed sides is done with bolts without anchor, our beds have secure, specially designed, hidden metal clips made by renown Italian manufacturer, which, together with wooden wedge enables tight connection and long-term stability.

### Well LINED

#### The bed with the beech laths floor

Lath floor of the bed gives a flat and stabile base for the mattress, thus providing its even loading. This enables a healthy and correct position of the spinal column and the whole body during rest and sleep. The spaces between the laths allow good air circulation around the mattress and its ventilation.

### Strong SUPPORT

#### Perfect background for every mattress

At the middle of support rail on the bed, where laths are attached, we have mounted two legs, in order to allow height adjustment of the bed. This way, very simple and easily you get a perfectly flat surface for a mattress, regardless to the floes of the floor where the bed is located.

### Live with NATURE

#### Natural materials in your home

Beds made of beech wood, are bringing the warmth of natural materials to your home. They are stabile and long lasting. The sides of the bed are made of 25 mm, the side walls and the wooden trestles of 30 mm solid wood plate, which gives a special stability and firmness to the bed.

### Under THE BED

#### Easy available and always clean

In order to have bedroom a healthy place to rest, it is very important that they are easily cleaned. Therefore we have especially emphasized that all "WOODY" beds are lifted on trestles, making the floor absolutely accessible for maintenance.

# WOODY KREVETI

WOODY BEDS



# Woody Soft Lux

BRAČNI KREKET  
SA TAPACIRANIM UZGLAVLJEM

DOUBLE BED  
WITH UPHOLSTERED HEADBOARD

dimenzija/dimension:  
215,5 x 169 x 85 cm

dimenzija za dušek/dimension for mattress:  
160 x 200 cm

Dezeni / Colors



Belo  
White

Wenge  
Wenge

Hrast  
Oak

Sivi štof  
Grey cloth

Bež štof  
Beige cloth

Bež štof  
Beige cloth



Krevet MASIV Soft LUX, dodir modernog dizajna u skladu sa funkcijom i zagarantovanim kvalitetom. Tapacirano uzglavlje bračnog kreveta od punog bukovog drveta Soft LUX, kompletira krug komfora u vašoj spavaćoj sobi. Visokokvalitetni mebl štof, rezistentan na habanje i cepanje dostupan u tri dezena. Bračni krevet od punog bukovog drveta sa hermetički zatvorenom kutijom za posteljinu. Metalni sistem spajanja stranica kreveta. Naši kreveti od drveta, imaju skrivena metalna ojačanja u vidu spojnice, što u kombinaciji sa tiplovima čini neraskidivu vezu i garantuje dugogodišnju stabilnost. Kao podlogu za dušek izabrali smo Latoflex. Metalni ram sa blago pomerljivim zglobnim nosačima letvica proizvodi efekat tzv. plutajuće podloge. Jednim blagim pokretom na gore podižete Latoflex, postavljen na podiznim gasnim amortizerima i sa lakoćom pristupate velikom prostoru za odlaganje.



Središnji oslonac osim što ukrućuje krevet, koristan je i zbog bolje organizacije prostora u kutiji za odlaganje.

*The central support, apart from strengthening a bed is also useful for better organization of the space in the storage box.*

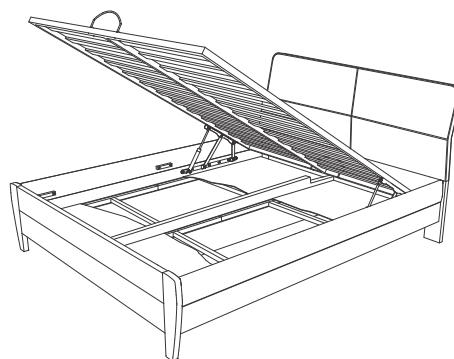

*Bed MASIV Soft LUX, touch of modern design in accordance with function and guaranteed quality. Upholstered headrest of Soft Lux bed made of beech wood completes the circle of comfort in your bedroom. High quality fabric, wear resistant and tearing resistant, is available in 3 designs. Beech wood double bed with hermetically sealed bedding box. Metal system of connection bed sides. Our wooden beds have hidden metal reinforcement in the form of couplings, which in combination with the anchors make unbreakable bond and guarantee long term stability. We selected Latoflex as a mattress base. Metal frame with movable articulated battens produces the effect of the so-called floating ground. With a slight gentle movement lift up the Latoflex, positioned on the lifting gas shock absorbers and easily access a large storage area.*

LATOFLEX



ID 346009  
belo / white

LATOFLEX



ID 346006  
wenge/wenge

LATOFLEX



ID 346012  
hrast / oak

# WOODY KREVETI

WOODY BEDS



# Woody Soft New

## BRAČNI KREKET DOUBLE BED

dimenzija/dimension:  
215,5 x 169 x 85 cm

dimenzija za dušek/dimension for mattress:  
160 x 200 cm

### Dezeni / Colors



Belo  
White

Wenge  
Wenge

Hrast  
Oak



Bračni krevet MASIV Soft New od punog bukovog drveta sa hermetički zatvorenom kutijom za posteljinu. Metalni sistem spajanja stranica kreveta. Naši kreveti od drveta, imaju skrivena metalna ojačanja u vidu spojnica, što u kombinaciji sa tiplovima čini neraskidivu vezu i garantuje dugogodišnju stabilnost. Kao podlogu za dušek izabrali smo Latoflex. Metalni ram sa blago pomerljivim zglobnim nosačima letvica proizvodi efekat tzv. plutajuće podloge. Jednim blagim pokretom na gore podižete Latoflex, postavljen na podiznim gasnim amortizerima i sa lakoćom pristupate velikom prostoru za odlaganje. Pogodan i za male stanove, štedi vam prostor i garantuje komfor!

*Double bed MASIV Soft New made of beech wood with hermetically sealed bedding box. Metal system of connection bed sides. Our wooden beds have hidden metal reinforcement in the form of couplings, which in combination with the anchors make unbreakable bond and guarantee long term stability. We selected Latoflex as a mattress base. Metal frame with movable articulated battens produces the effect of the so-called floating ground. With a slight gentle movement lift up the Latoflex, positioned on the lifting gas shock absorbers and easily access a large storage area.*



### 1 SASVIM NEŽNO savršeno i za decu i za odrasle

Sasvim zasluženo i s ponosom, ovaj model kreveta nosi ime SOFT. Primenom softverskih 3D paketa za projektovanje, a potom izradom na kompjuterski upravljanim obradnim centrima i preciznom završnom obradom, osmišljen je krevet na kome su sve ivice zaobljene što, osim izražene estetike, donosi i jednu potpuno novu dimenziju komfora.

#### TOTALLY GENTLE Perfect for children and adults

*Completely deserved and proudly this model is named Soft bed. The application of 3D software package for design and then making the same bed on a computer-controlled machines with precise finishing we have designed a bed on which all edges are rounded, therefore besides expressed aesthetics there is an entirely new dimension of comfort.*



### 2 NEČUJNO I LAGANO Do posteljine bez muke i buke

Najsavremeniji mehanizam za podizanje i spuštanje platforme sa dušekom, u koji su ugrađena dva amortizera jačine 750 N, omogućavaju jednostavan pristup prostoru za odlaganje posteljine. Sasvim nečujno i lagano, bez buke i napora.

#### SILENT AND LIGHTWEIGHT Get your bedding without the annoyance and noise

*The most modern mechanism for raising and lowering the mattress platform, that has two integrated gas shock absorbers combined strength of 750 N, allowing easy access to bedding storage. Silently and smoothly, without noise or effort.*



ID 345909  
belo / white



ID 345906  
wenge/wenge



ID 345912  
hrast / oak

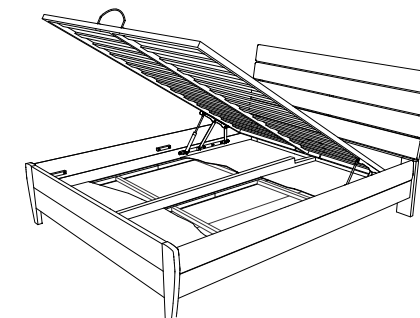
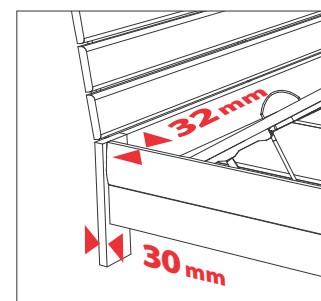

# WOODY KREVETI

WOODY BEDS



# Woody BOX

## BRAČNI KREKET / DOUBLE BED

dimenzija/dimension: 207 x 167,6 x 85 cm

dimenzija za dušek/dimension for mattress: 160 x 200 cm

Dezeni / Colors



Bukva Beech Trešnja Cherry Wenge Wenge Hrast Oak Belo White

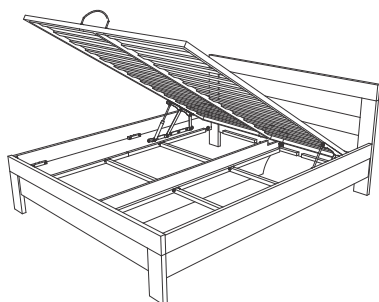

**ID 344301**  
bukva / beech



**ID 344303**  
trešnja / cherry



**ID 344306**  
wenge / wenge



**ID 344312**  
hrast / oak



**ID 344309**  
belo / white

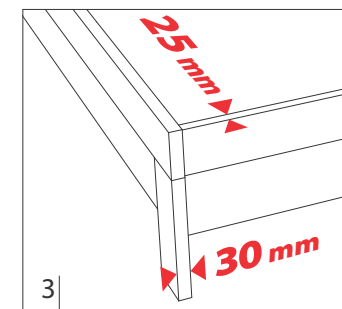

# Woody BOX

## SAMAC SINGLE

dimenzija/dimension: 207 x 97,6 x 85 cm

dimenzija za dušek/dimension for mattress: 90 x 200 cm

Dezeni / Colors



Bukva Beech Trešnja Cherry Wenge Wenge Hrast Oak Belo White

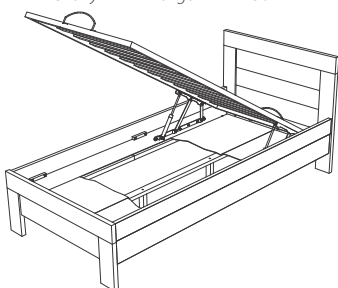

**ID 344201**  
bukva / beech



**ID 344203**  
trešnja / cherry



**ID 344206**  
wenge / wenge



**ID 344212**  
hrast / oak



**ID 344209**  
belo / white



# WOODY KREVETI

WOODY BEDS







### 1 I ŠTITI I ŠTEDI Dvostruka vrednost prostora za posteljinu

Prostor predviđen za odlaganje posteljine hermetički je zatvoren i onemogućava upadanje prašine. Ovaj prostor, takođe i štedi prostor u spavaćoj sobi, jer vam za odlaganje posteljine nisu potrebne dodatne komode, a soba će uvek biti sređena i uredna.

**PROTECTS AND SAVES**  
Double space for bedding

The space provided for storage of bedding is closed hermetically, preventing the intrusion of dust. This space also saves the space in the bedroom itself, because there is no need for additional cabinets. The room will always be tidy and neat.



### 3 DOBRO PAKOVANJE Potpuna zaštita od oštećenja

Svi delovi Woody kreveti se pakuju u kartonske kutije. Uglovi i drugi delovi osetljivi na oštećenja su dodatno obloženi i zaštićeni stiroporom, te je mogućnost bilo kakvog oštećenja pri transportu

**GOOD PACKING**  
Complete protection from damage

All parts of "Woody" beds are packed in cardboard boxes. Edges and other parts susceptible to damaging are additionally coated and protected with Styrofoam, this way, the possibility of any damaging during transportation is reduced to minimal.

### LEPOTA JEDNOSTAVNOSTI Svedene linije za sve ukuse

Ravne linije i precizna završna obrada daju drvetu mogućnost da iskaže lepotu svojih karakteristika u punom sjaju. Osetite toplinu prirodnih materijala, uživajte u ambijentu koji će vas uvek podsećati da je priroda deo nas i mi deo nje.

**THE BEAUTY OF SIMPLICITY**  
Straight lines for all tastes

Straight lines and precise finishing of wood give the possibility to express the beauty of solid wood characteristics in all its glory. Feel the warmth of natural materials, enjoy the ambience that will always remind you that nature is part of us and that we are the part of nature.

### OSTALE DIMENZIJE KREVETA WOODY BOX OTHER DIMENSIONS OF BED WOODY BOX

Dezen / colour	za dušek / for mattress 140 x 200 cm	za dušek / for mattress 180 x 200 cm
bukva/beech	ID 345001	ID 345101
trešnja/cherry	ID 345003	ID 345103
wenge/wenge	ID 345006	ID 345106
hrast/oak	ID 345012	ID 345112
4   belo/white	ID 345009	ID 345109



### 4 NAJBOLJE UKLAPANJE Izrada i u nestandardnim dimenzijama

Ovaj model WOODY kreveta proizvodi se i u nestandardnim merama 140 x 200 cm i 180 x 200 cm. Odaberite dimenziju koja vam odgovara i jednu od 5 boja iz palete koja je u ponudi. Svakako ćete novi krevet savršeno moći da uklopite u svaki prostor.

**THE BEST FIT**  
Non standard dimension production

This model of "WOODY" beds is produced in the non-standard dimensions 140 x 200 cm and 180 x 200 cm. Select a dimension that suits you and one of five colors from the color palette and you'll definitely be able to perfectly match the new "WOODY" bed in every room.

### 5 JASTUK GLAVU ČUVA Puno uzglavlje za lepotu i zdravlje

Puno uzglavlje kreveta, osim estetskog efekta ima i veoma visoku funkcionalnost. Pruža čvrstu potporu za jastuk i štiti glavu i ramena od eventualnog strujanja hladnog vazduha.

**PILLOW GUARDS THE HEAD**  
Full headboard for beauty and health

The full headboard, except for its aesthetic effect has a very high functionality. It provides firm support for the pillow, which in this case cannot fall off the bed, protects the head and shoulders of a possible flow of the cold air.

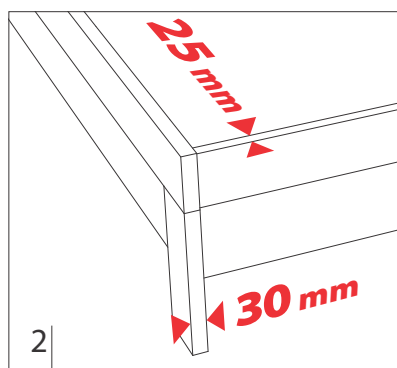

### 2 Središnji oslonac osim što ukrućuje krevet, koristan je i zbog bolje organizacije prostora u kutiji za odlaganje.

The central support, apart from making a bed, is also useful for the better organization of the space in the storage box.

# WOODY KREVETI

WOODY BEDS



# Woody Classic

## BRAČNI KREVET / DOUBLE BED

dimenzija/dimension: 207 x 167,6 x 85 cm

dimenzija za dušek/dimension for mattress:

160 x 200 cm

Dezeni / Colors



Bukva  
Beech

Wenge  
Wenge

Hrast  
Oak

Belo  
White

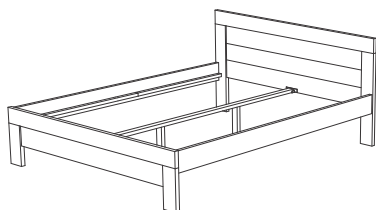

30 mm  
DRVO  
WOOD

# Woody Classic

## SAMAC SINGLE

dimenzija/dimension: 207 x 97,6 x 85 cm

dimenzija za dušek/dimension for mattress:

90 x 200 cm

Dezeni / Colors



Bukva  
Beech

Wenge  
Wenge

Hrast  
Oak

Belo  
White

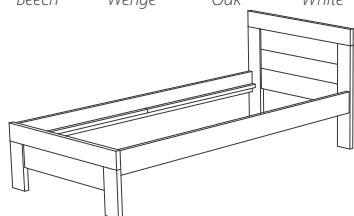

Klasičan model koji se lako uklapa u svaki prostor. Pogodan za opremanje kuća i stanova. Vrlo ekonomičan i praktičan za hotele, vile, odmarališta. Odignut nogarima od poda daje mogućnost jednostavnog čišćenja i održavanja.

*The classic model is easy to fit into any space. Suitable for furnishing houses and apartments. Very economical and practical for hotels, villas and resorts. Trestle lifted from the floor allows you easy cleaning and maintenance.*

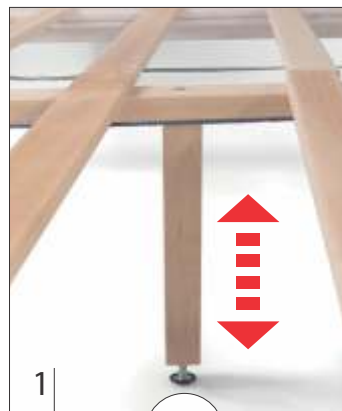

### 1 SAVRŠENO RAVNO Nivelacija podloge duška

Na srednju potpornu letvu kreveta, montirana su dva nogara za podešavanje visine. Tako se veoma jednostavno i lako može dobiti savršeno ravna podloga za dušek, bez obzira na eventualne nedostatke poda na kome se krevet nalazi.

**PERFECTLY EVEN**  
Leveling mattress pads

*At the middle support rail of the bed, we have mounted two legs, in order to allow height adjustment of the bed. This way, very simple and easily you get a perfectly flat surface for a mattress, regardless to the floors of the floor where the bed is located.*

### 2 POVAŠOJ ŽELJI Mogućnost izbora potpore za dušek

Jedino kod ovog modela kreveta možete birati podnicu za dušek. Drvene letvice ili LATOFLEX u metalnom ramu? Oba rešenja imaju svojih prednosti, pa je vaš izbor stvar individualnog afiniteta ili starih navika. Možda je i vreme za promene?

**YOUR CHOICE**  
Choose a mattress support

*Only at this model of beds you can choose how to support the mattress. Wooden laths or LATOFLEX in a metal frame? Both solutions have their advantages, so your choice is a matter of individual affinity or old habits. Maybe it is time for a change?*

## OSTALE DIMENZIJE KREVETA WOODY CLASSIC / OTHER DIMENSIONS OF BED WOODY CLASSIC

Dezen/ color	ID za dušek / ID for mattress 140 x 200 cm					ID za dušek / ID for mattress 180 x 200 cm						
	krevet/bed	letvice/laths	latoflex/latoflex	A+B	A+C	krevet/bed	letvice/laths	latoflex/latoflex	A+B	A+C		
bukva/beech	OKV345201	B	LET140200	C	ML140200	OKV345301	B	LET180200	C	ML180200	345301	345501
wenge/wenge	OKV345206					OKV345306					345306	345506
hrast/oak	OKV345212					OKV345312					345312	345512
belo/white	OKV345209					OKV345309					345309	345509

Šifre koje važe samo za kupce sa INO tržišta / ID for foreign markets ONLY

# Woody Classic 90 x 200 cm

Šifre koje važe samo za kupce sa INO tržišta / ID for foreign markets ONLY



# Woody Classic 160 x 200 cm

Šifre koje važe samo za kupce sa INO tržišta / ID for foreign markets ONLY

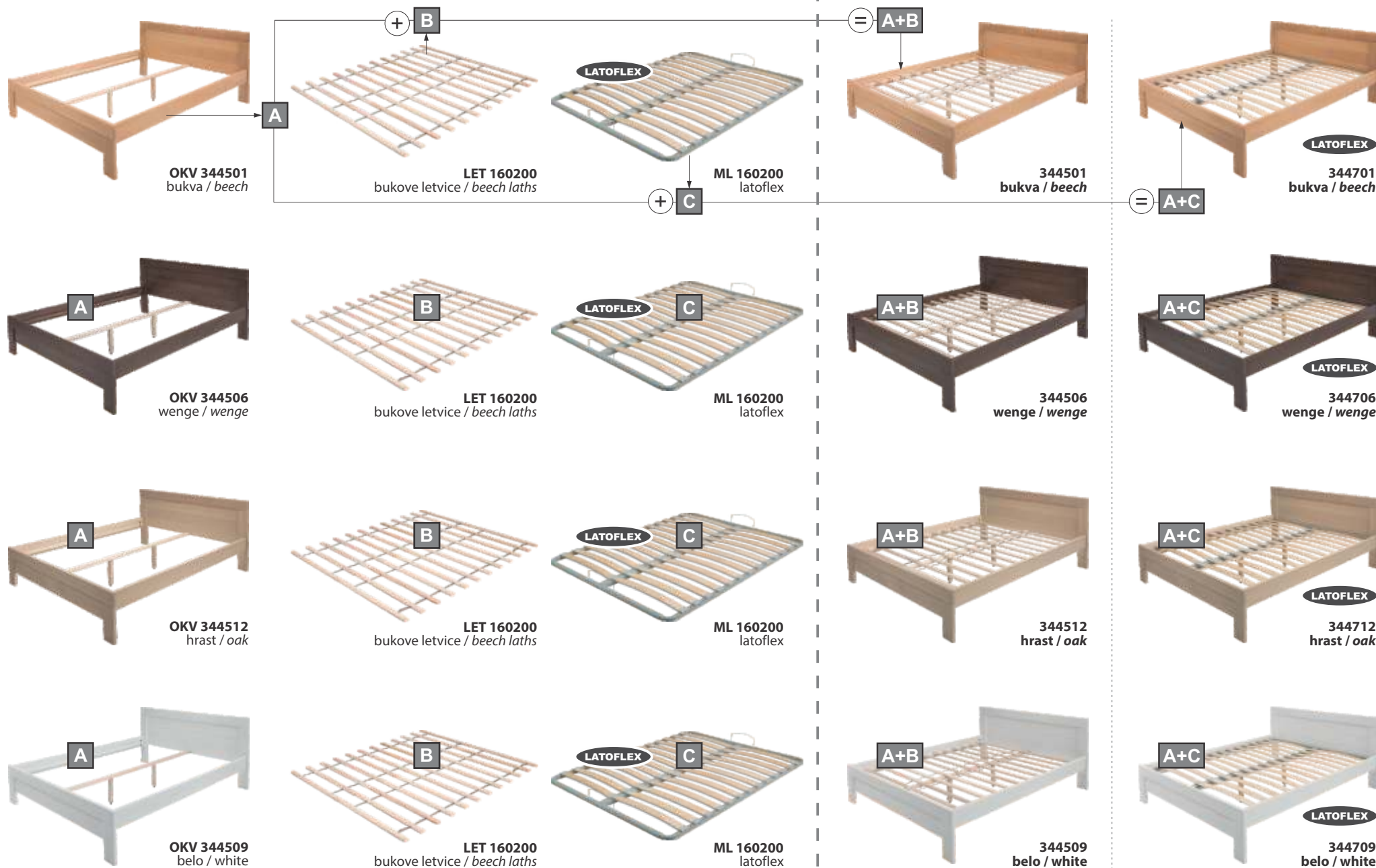





# Intro New Mebl

## BRAČNI KREKET / DOUBLE BED

dimenzija/dimension:  
205 x 165 x 94 cm

dimenzija za dušek/dimension for mattress:  
200 x 160 cm

### Dezeni / Colors

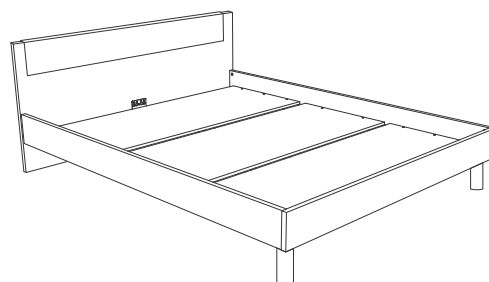
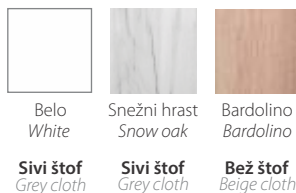

Čvrsta baza podkonstrukcije od univera visokog kvaliteta uneće prirodnu toplinu u vašu spavaću sobu. Savršeno će se ukombinovati sa velikim brojem plakara i komoda iz jedinstvene Matis proizvodne ponude. Nudimo vam kvalitetno sklopljen i stabilan bračni krevet Intro, minimalističkog dizajna koji je primamljiv svakom budžetu.

*A solid base of subconstruction made of high quality chipboard will bring you warmth in your bedroom. It will perfectly combine with numerous wardrobes and cupboards from unique Matis produce offer.*



**ID 355146**  
snežni hrast / snow oak



**ID 355109**  
belo / white



**ID 355112**  
hrast-bardolino / oak-bardolino

**NAPOMENA: Podnica kreveta uključena je u cenu.**  
**NOTE: Bed floor is included in the price.**

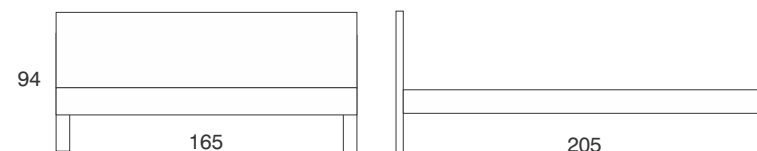





# NORDIC

## BRAČNI KREKET / DOUBLE BED

dimenzija/dimension: 206 x 166 x 73 cm

dimenzija za dušek/dimension for mattress:

160 x 200 cm

Dezeni / Colors



Snežni hrast  
Snow oak

Bardolino  
Bardolino

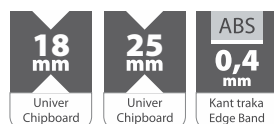
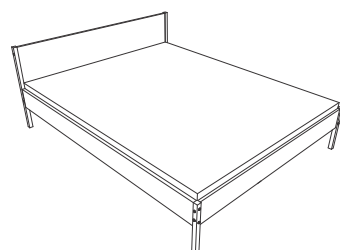

# NORDIC

## SAMAC / SINGLE

dimenzija/dimension: 206 x 96 x 73 cm

dimenzija za dušek/dimension for mattress:

90 x 200 cm

Dezeni / Colors



Snežni hrast  
Snow oak

Bardolino  
Bardolino

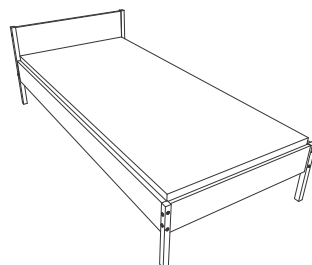

**Srednja letva od masiva**  
vezana metalnim ugaonikom  
Medium massive lath  
bonded with metal corners



**25 mm**  
bokovi kreveta  
25 mm  
bed sides



**Nogari kreveta**  
od masivnog drveta 30x30 mm  
Bed legs  
solid wood 30x30 mm



**Čelični**  
elementi veze  
Steel  
connectors

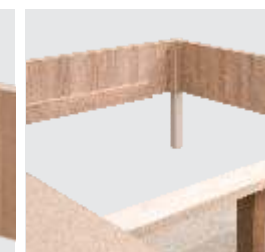

**Srednji nogar od masiva**  
stabilnost  
Medium massive leg  
stability



SAMAC / SINGLE  
**ID 350146**  
snežni hrast / snow oak  
**ID 350112**  
bardolino / bardolino



BRAČNI KREKET / DOUBLE BED  
**ID 350246**  
snežni hrast / snow oak  
**ID 350212**  
bardolino / bardolino



# DEČIJE SOBE

## CHILDREN ROOMS

Jedan od najvažnijih elemenata u odrastanju svakog deteta predstavlja i životni prostor u kome ono provodi vreme. Bitno je da ovaj prostor odgovara njegovim godinama i potrebama, ali i da oslikava detetovu ličnost na što bolji način i zadovoljava svu njegovu znatiželju, kao i potrebu za specifičnom vrstom funkcionalnosti, koja je svakom mališanu potrebna.

*One of the most important elements in the growth of every child is the living space in which it spends time. It is important that this space corresponds to his age and needs, but also to reflect the child's personality in the best way and satisfies all his curiosity, as well as the need for the specific type of functionality that every child needs.*



# NUMERO

Dečije sobe **NUMERO** izrađene su od univera 18 i 25 mm. Kombinacija modernog dezena korpusa i širok spektar boja frontova pružaju kako devojčicama, tako i dečacima pravo zadovoljstvo uživanja.

*NUMERO children's rooms are made of univer 18 and 25 mm. Combination of modern design of the corps and a wide range of front colors. They provide both girls and boys real pleasure of enjoyment.*



## Lice / Front



Ljubičasta Violet    Zelena Green    Pink    Kameno siva Stone gray    Plava Blue

## Korpus / Corps



Beli hrast  
White oak

<b>18 mm</b> Univer Chipboard	<b>25 mm</b> Univer Chipboard	<b>ABS</b> <b>1 mm</b> Kant traka Edge Band	<b>ABS</b> <b>0,4 mm</b> Kant traka Edge Band
<b>Plastic</b> Ručica Handle	<b>Nogari</b> Stands	<b>Slow motion</b> Zatvaranje Closing	<b>Hanger</b> Gard. šipka Hanger

- |   |   |   |
|---|---|---|
| <b>1</b> Vitrina 1V / Showcase 1V             | <b>7</b> O1V2F / O1V2F                                | <b>12</b> Fioka kreveta / Bed drawer            |
| <b>2</b> Most radnog stola / Work desk bridge | <b>8</b> Most kreveta / Bed bridge                    | <b>13</b> Klub sto / Club table                 |
| <b>3</b> Polica 80 / Shelf 80                 | <b>9</b> Polica 80 / Shelf 80                         | <b>14</b> Komoda 2F niša / Cupboard 2F open box |
| <b>4</b> Polica 40 / Shelf 40                 | <b>10</b> Kutija posteljina / Bedding box             | <b>15</b> Radni sto / Work desk                 |
| <b>5</b> O2V4F niša / O2V4F open box          | <b>11</b> Numero krevet 90 2F D<br>Numero bed 90 2F R |   |
| <b>6</b> Ugaoni ormar / Corner closet         |   |   |







1 Most kreveta / Bed bridge

2 Polica 80 / Shelf 80

3 Polica 40 / Shelf 40

4 O3V2F / O3V2F

5 Ugaoni ormar / Corner closet

6 O1V2F / O1V2F

7 O2V4F niša / O2V4F open box

8 Most radnog stola / Work desk bridge

9 Polica brojevi / Numbers shelf

10 Radni sto / Work desk

11 Komoda 2F niša / Cupboard 2F open box

12 Klub sto / Club table

13 Numero krevet 90 2FL / Numero bed 90 2FL

14 Fioka kreveta / Bed drawer

15 Kutija posteljina / Bedding box

1 O2V2F / O2V2F

2 Numero krevet na sprat / Numero bunk bed

3 Fioka kreveta / Bed drawer

4 Most radnog stola / Bridge work desk

5 Polica 80 / Shelf 80

6 O1V2F / O1V2F

7 O2V4F niša / O2V4F open box

8 Bočna polica / Side shelf

9 Radni sto / Work table

10 Komoda 2F niša / Cupboard 2F open box

11 Klub sto / Club table



1

6

9

3

4

- |                                |  |                                   |
|--------------------------------|--|-----------------------------------|
| 1 Most kreveta / Bed bridge    | 6 Bočna polica / Side shelf              | 11 Polica brojevi / Numbers shelf |
| 2 Vitrina 1V / Showcase 1V     | 7 Klub sto / Club table                  | 12 Polica 40 / Shelf 40           |
| 3 Kosa polica / Curve shelf    | 8 Numero krevet 120 / Numero bed 120     | 13 Polica 80 / Shelf 80           |
| 4 Ugaoni ormar / Corner closet | 9 Radni sto / Work desk                  |                                   |
| 5 O2V2F / O2V2F                | 10 Komoda 2F niša / Cupboard 2F open box |                                   |



# NUMERO

- |  |  |  |
|--|--|--|
| 1 Most kreveta / Bed bridge            | 7 O1V2F / O1V2F                          | 13 Radni sto / Work desk                 |
| 2 Most radnog stola / Work desk bridge | 8 O2V4F niša / O2V4F open box            | 14 Polica brojevi / Numbers shelf        |
| 3 Vitrina 1 V / Showcase 1V            | 9 Bočna polica / Side shelf              | 15 Komoda 3F niša / Cupboard 3F open box |
| 4 Kosa polica / Curve shelf            | 10 Klub sto / Club table                 | 16 Polica 80 / Shelf 80                  |
| 5 Ugaoni ormar / Corner closet         | 11 Numero krevet 120 / Numero bed 120    |  |
| 6 O2V2F / O2V2F                        | 12 Komoda 2F niša / Cupboard 2F open box |  |

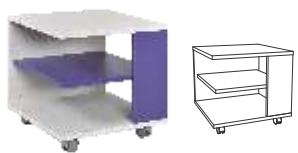

**Numero klub sto**  
Numero club table  
45x45x43 cm  
ID 5815\*\*



**Numero polica brojevi**  
Numero numbers shelf  
120x22x54 cm  
ID 5801\*\*

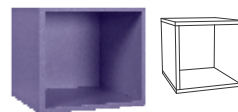

**Numero viseća niša**  
Numero hanging open box  
40x40x35 cm  
ID 5806\*\*



**Numero polica 80**  
Numero shelf 80  
80x20x23,5 cm  
ID 5816\*\*

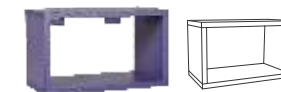

**Numero polica 40**  
Numero shelf 40  
40x20x23,5 cm  
ID 5811\*\*



**Numero komoda 2F niša**  
Numero cupboard 2F open box  
40x42x60 cm  
ID 5854\*\*

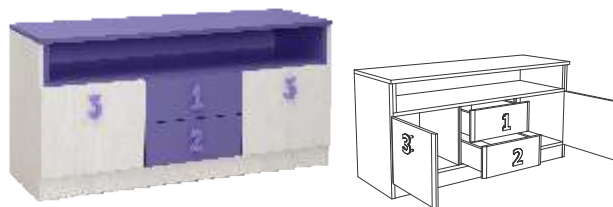

**Numero TV komoda**  
Numero TV stand  
120x42x60 cm  
ID 5805\*\*



**Numero komoda 3F niša**  
Numero cupboard 3F open box  
80x52x75 cm  
ID 5843\*\*



**Numero radni sto**  
Numero work desk  
120x60x75/93 cm  
ID 5804\*\*



**Numero O3V2F**  
Numero O3V2F  
120x52x217,5 cm  
ID 5850\*\*



**Numero O2V4F niša**  
Numero O2V4F open box  
80x52x217,5 cm  
ID 5840\*\*



**Numero O2V2F**  
Numero O2V2F  
80x52x217,5 cm  
ID 5849\*\*



**Numero ugaoni ormar**  
Numero corner closet  
92,5/52x90,5/52x217,5 cm  
ID 5853\*\*

92,5 cm  
90,5 cm  
52 cm  
52 cm  
**UŠTEDA  
PROSTORA**  
SPACE SAVING



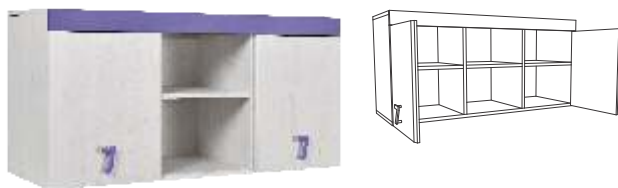

**Most radnog stola**  
Numero work desk bridge  
120x42x57,5 cm  
ID 5845\*\*



**Most kreveta**  
Numero bed bridge  
205x42x57,5 cm  
ID 5844\*\*

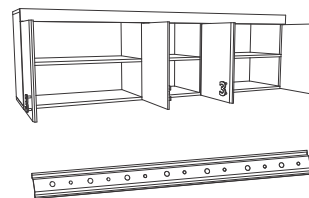

**Kačenje: metalna šina**  
Hanging metal rail



**Numero krevet na sprat**  
Numero bunk bed  
za dušek 90x200  
205x102,5x175 cm  
ID 584754

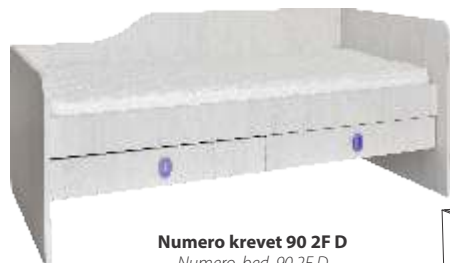

**Numero krevet 90 2F D**  
Numero bed 90 2F D  
205x102,5x90 cm  
ID 5860\*\*D

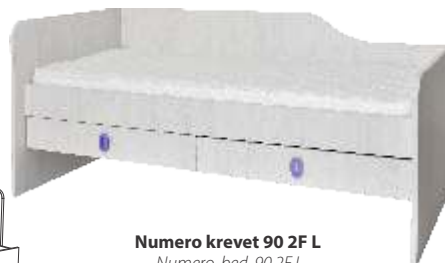
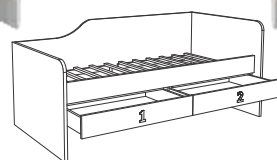

**Numero krevet 90 2F L**  
Numero bed 90 2F L  
205x102,5x90 cm  
ID 5860\*\*L



**Numero kutija posteljina**  
Numero bedding box  
30x102,5x92 cm  
ID 5802\*\*



**Numero krevet 120**  
Numero bed 120  
205x125x90 cm  
ID 584954

\* Pod kreveta od šperploče uključen je u cenu \* Bed floor of plywood is included in price



**Numero kosa polica**  
Numero curve shelf  
Univerzalna L i D / Universal L&R  
40x40/50x217,5 cm  
ID 584054



**Numero bočna polica**  
Numero side shelf  
22x50x217,5 cm  
ID 5810\*\*



**Numero vitrina 1V**  
Numero showcase 1V  
40x42x217,5 cm  
ID 5846\*\*

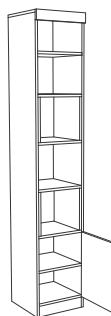

**Numero O1V2F**  
Numero O1V2F  
40x52x217,5 cm  
ID 5847\*\*

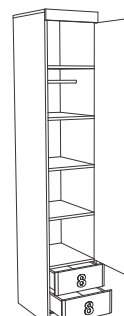

**Numero komoda 4F niša**  
Numero cupboard 4F open box  
40x42x126,5 cm  
ID 5855\*\*



**Numero fioka kreveta**  
Numero bed drawer  
199,5x94x23 cm  
ID 5800\*\*

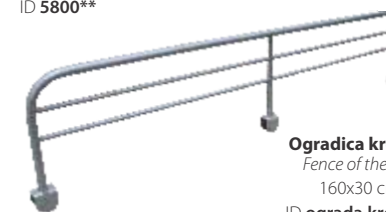
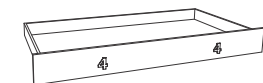

**Ogradica kreveta**  
Fence of the bed  
160x30 cm  
ID ograda.kreveta

NAPOMENA Krila elemenata imaju nečujno (slow motion) zatvaranje  
NOTE: The wings of the elements have a slow motion closure

- 1 Happy KOM 1F / Happy KOM 1F
- 2 Happy KOMP STO / Happy COMP desk
- 3 Happy O1V / Happy KOM 1F
- 4 Happy POL 100 / Happy POL 100
- 5 Happy TV KOM / klub sto  
Happy TV KOM / club table
- 6 Pikolo klub set / Piccolo club set
- 7 Happy O POL 40 x 153  
Happy O POL 40 x 153
- 8 Happy KL POL 80x 153  
Happy KL POL 80x 153
- 9 Happy KOM 3F / Happy POL 100
- 10 Happy O3V2F / Happy O3V2F
- 11 Happy KR 90 / Happy KR 90
- 12 Happy fioka KR / Happy drawer KR
- 13 Happy NORM / Happy NORM



# DEČIJE SOBE

## CHILDREN ROOMS

Svetli i veseli tonovi Happy sobe unose svetlost u Vaš dom. Dodatno osveženje donose i fragmenti stakala u tri dezena. Veliki broj kombinacija 21 elementa je argument koji se ne može zanemariti u odabiru Vaše sobe.

*Bright and cheerful tones of the Happy room bring light in your home. Glass fragments in three designs are bringing additional refreshments! A large number of combinations of twenty two elements is an argument that can not be ignored in the selection of your room.*

# Happy

BELO / WHITE

\*\* Staklo / glass

<b>18</b>	<b>22</b>	<b>29</b>
Zeleno Green	Sivo Grey	Lila Violet

Korpus / Corps



Belo  
White

Lice / Front



Belo sjaj  
White gloss

<b>18 mm</b> Univer Chipboard	<b>25 mm</b> Univer Chipboard	<b>ABS</b> <b>2 mm</b> Kant traka Edge Band	<b>ABS</b> <b>1 mm</b> Kant traka Edge Band	<b>ABS</b> <b>0,4 mm</b> Kant traka Edge Band
 Nivelacija Adjusting	 Otvaranje Opening	 Plastic Ručica Handle	 Nogari Stands	 AL Rukohvat Handle
 <b>Hanger</b> Gard. šipka Hanger				



- |   |  |   |  |
|---|--|---|--|
| ① | Happy KR BOK / Happy KR BOK                      | ⑦ | Happy O2V2F / Happy O2V2F                      |
| ② | Happy POL 100 / Happy POL 100                    | ⑧ | Happy O POL 40 x 153<br>Happy O POL 40 x 153   |
| ③ | Happy O1V / Happy O1V                            | ⑨ | Happy KOMP STO<br>Happy COMP DESK              |
| ④ | Happy VEL POL / Happy VEL POL                    | ⑩ | Happy KL POL 80 x 153<br>Happy KL POL 80 x 153 |
| ⑤ | Happy TV KOM klub sto<br>Happy TV KOM club table | ⑪ | Happy fioka KR / Happy drawer KR               |
| ⑥ | Pikolo klub set / Piccolo club set               |   |  |



1 Happy KOM 3F / Happy KOM 3F

2 Happy POL 100 / Happy POL 100

3 Happy TV KOM / klub sto  
Happy TV KOM/ club table

4 Happy O2V2F / Happy O2V2F

5 Pikolo klub set / Piccolo club set

6 Krevet na sprat / Bunk bed

7 Happy fioka KR / Happy drawer KR



- |   |  |   |  |
|---|--|---|--|
| 1 | Krevet na sprat / Bunk bed                       | 5 | Happy O POL 40 x 153<br>Happy O POL 40 x 153 |
| 2 | Happy O2V2F / Happy O2V2F                        | 6 | Happy KOMP STO<br>Happy COMP DESK            |
| 3 | Happy TV KOM klub sto<br>Happy TV KOM club table | 7 | Happy fioka KR / Happy drawer KR             |
| 4 | Happy POL 100 / Happy POL 100                    |   |  |



1 Happy KR BOK / Happy KR BOK

2 Happy POL 100 / Happy POL 100

3 Happy V POL 80 x 190  
Happy V POL 80 x 190

4 Happy VEL POL / Happy VEL POL

5 Happy KOMP STO  
Happy COMP DESK

6 Happy V POL 40 x 190  
Happy V POL 40 x 190

7 Happy O1V / Happy O1V

8 Happy O3V2F / Happy O3V2F

9 Happy TV KOM klub sto  
Happy TV KOM club table

10 Happy fioka KR / Happy drawer KR

**25 mm**  
Univer  
Chipboard

**ABS**  
**1 mm**  
Kant traka  
Edge Band



**Happy NORM**  
*Happy NORM*  
42 x 38 x 52 cm  
ID 490209



**Happy KOM 1F**  
*Happy KOM 1F*  
42 x 38 x 75 cm  
ID 490109



**Happy KOM 3F**  
*Happy KOM 3F*  
78 x 52 x 88 cm  
ID 490309



**Happy TV KOM / klub sto**  
*Happy TV KOM / club table*  
100 x 50 x 50 cm  
ID 490509



**Happy KOMP STO**  
*Happy COMP desk*  
100 x 50 x 75 cm  
ID 490409



**Happy KR 120**  
*Happy KR 120*  
126 x 206 x 74,5 cm  
ID J490809

**DRVENI NOGARI**  
**WOODEN LEGS**



**Happy KR BOK**  
*Happy KR BOK*  
95 x 206 x 63 cm  
ID J490609

**DRVENI NOGARI**  
**WOODEN LEGS**



**Happy KR 90**  
*Happy KR 90*  
95 x 206 x 72 cm  
ID J490709



**Happy fioka KR**  
*Happy drawR KR*  
199 x 91 x 18 cm  
ID J490909

\* Pod kreveta od šperploče uključen je u cenu \* *Bed floor of plywood is included in price*

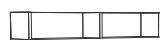

**Happy POL 100**  
*Happy POL 100 shelf*  
100 x 22 x 18,5 cm  
ID J491009



**Happy V POL 80 x 190**  
*Happy V POL 80 x 190 / shelf*  
80 x 38 x 190 cm  
ID 491309

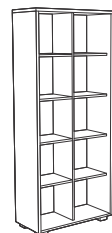

**Happy V POL 40 x 190**  
*Happy V POL 40 x 190 / shelf*  
42 x 38 x 190 cm  
ID 491209



**Happy O POL 40 x 153**  
*Happy O POL 40 x 153 / shelf*  
42 x 38 x 153 cm  
ID 491109

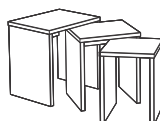

**Pikolo klub set**  
*Piccolo club set*  
45 x 38 x 48 cm  
ID J210509



25 mm  
Univer  
Chipboard

ABS  
2 mm  
Kant traka  
Edge Band



Krevet na sprat  
Bunk bed  
205 x 96,4 x 173,5 cm  
ID J492309

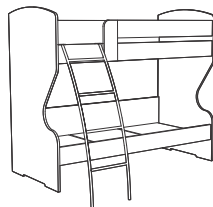

25 mm  
Univer  
Chipboard



Happy KL POL 80 x 153  
Happy KL POL 80 x 153 shelf  
80 x 38 x 153 cm  
ID 4916\*\*

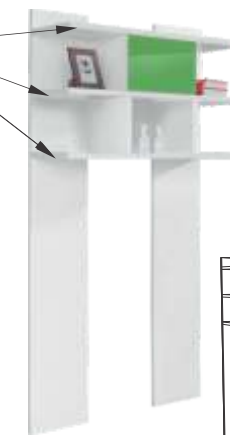

Happy VEL POL  
Happy VEL POL  
100 x 32 x 190 cm  
ID 4915\*\*



Happy



Happy

220 cm



Happy O1V  
Happy O1V  
45 x 54 x 220 cm  
ID 4918\*\*

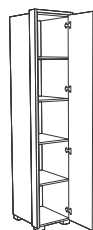

Happy O2V  
Happy O2V  
85 x 54 x 220 cm  
ID 4919\*\*

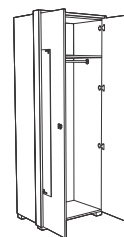

25 mm  
Univer  
Chipboard

ABS  
1 mm  
Kant traka  
Edge Band



Happy O2V2F  
Happy O2V2F  
85 x 54 x 220 cm  
ID 4920\*\*

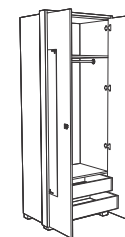

Happy O3V2F  
Happy O3V2F  
125 x 54 x 220 cm  
ID 4921\*\*

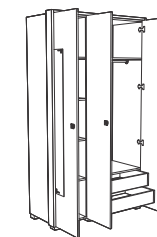



1

3

4

2

# Happy

HRAST / OAK

Česte su situacije kada se želje dece i tinejdžera ne poklapaju sa željama roditelja. Kompanija Matis je rešila da napravi savršeni kompromis i ponudi Vam dečije sobe Happy, dizajnirane tako da se dopadaju najmlađima, a funkcionalne toliko da mogu da prođu i najrigoroznije testove odraslih. Dečije sobe Happy su prava sredina za formiranje ispravnog karaktera i zdravih navika, na zabavan i bezbedan način.

*There are frequent situations where the desires of children and teenagers do not match with the wishes of parents. Company Matis has decided to make the perfect compromise and offer you Happy children's rooms, designed to appeal to the youngest and functional so that they can pass the most rigorous adult tests. Happy Room Happy Rooms are the right environment for creating the right character and healthy habits, in a fun and safe way.*

Korpus / Corps



Hrast  
Oak

Lice / Front



Šampanj  
Champagne

- 1 Happy V POL 40 x 190
- 2 Happy KOMP STO / Happy COMP DESK
- 3 Happy VEL POL / Happy VEL shelf
- 4 Happy O2V
- 5 Matisan dušek 80 x 190  
Matisan mattress 80 x 190
- 6 Matisan dušek 90 x 200  
Matisan mattress 90 x 200
- 7 Krevet na sprat / Bunk bed
- 8 Happy fioka KR / Happy drawer KR
- 9 Happy TV KOM - klub sto  
Happy TV KOM - club table
- 10 Happy O3V2F

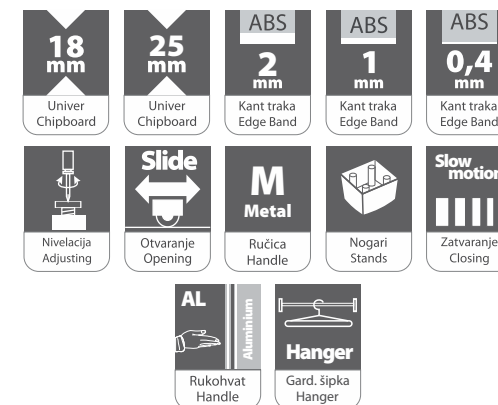



- 1 Happy fioka KR / Happy drawer KR
- 2 Happy KR 90
- 3 Klub set "Pikolo" / Club set Piccolo
- 4 Happy KOM 3F

- 5 Happy KOM 1F
- 6 Happy KOMP STO / Happy COMP DESK
- 7 Happy VEL POL / Happy VEL shelf
- 8 Happy O2V



- 1 Happy fioka KR / Happy drawer KR
- 2 Happy KR 90
- 3 Happy O2V2F
- 4 Happy KOM 1F

- 5 Happy POL 100
- 6 Happy KOMP STO / Happy COMP DESK
- 7 Happy V POL 80 x 190
- 8 Happy KOM 3F



- |   |                                  |   |  |
|---|----------------------------------|---|--|
| ① | Happy O POL 40 x 153             | ⑥ | Krevet na sprat / Bunk bed                           |
| ② | Happy KOMP STO / Happy COMP DESK | ⑦ | Happy fioka KR / Happy drawer KR                     |
| ③ | Happy POL 100                    | ⑧ | Happy O1V  |
| ④ | Happy V POL 40 x 190             | ⑨ | Happy TV KOM - klub sto<br>Happy TV KOM - club table |
| ⑤ | Happy O2V2F                      |   |  |



- ① Happy KR BOK
- ② Happy fioka KR / Happy drawer KR
- ③ Matisan dušek 80 x 190  
Matisan mattress 80 x 190
- ④ Happy KL POL 80 x 153

- ⑤ Happy KOM 1F
- ⑥ Happy VEL POL
- ⑦ Happy KOMP STO / Happy COMP DESK
- ⑧ Happy O2V

**25 mm**  
Univer  
Chipboard

**ABS**  
**1 mm**  
Kant traka  
Edge Band



**Happy N ORM**  
*Happy N ORM*  
42 x 38 x 52 cm  
ID J490212



**Happy KOM 1F**  
*Happy KOM 1F*  
42 x 38 x 75 cm  
ID J490112



**Happy KOM 3F**  
*Happy KOM 3F*  
78 x 52 x 88 cm  
ID J490312



**Happy TV KOM/klub sto**  
*Happy TV KOM / club table*  
100 x 50 x 50 cm  
ID J490512

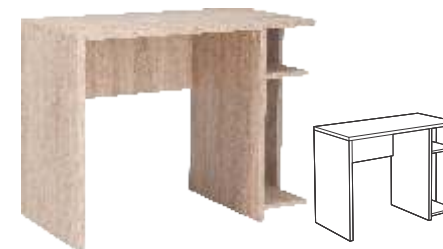

**Happy KOMP STO**  
*Happy COMP DESK*  
100 x 50 x 75 cm  
ID J490412



**Happy KR 120**  
*Happy KR BOK*  
126 x 206 x 74,5 cm  
ID J490812

**Happy KR BOK**  
*Happy KR 120*  
95 x 206 x 63 cm  
ID J490612

**Happy KR 90**  
*Happy KR 90*  
95 x 206 x 72 cm  
ID J490712

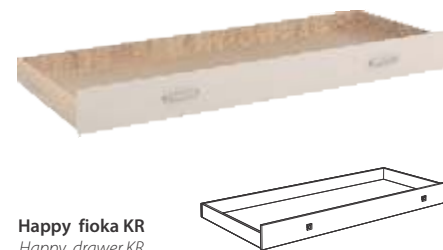

**Happy fioka KR**  
*Happy drawer KR*  
199 x 91 x 18 cm  
J 490912

\* Pod kreveta od šperploče uključen je u cenu \* *Bed floor of plywood is included in price*



**Happy POL 100**  
*Happy POL 100 shelf*  
100 x 22 x 18,5 cm  
ID J491012



**Happy V POL 80 x 190**  
*Happy V POL 80 x 190 / shelf*  
80 x 38 x 190 cm  
ID J491312



**Happy V POL 40 x 190**  
*Happy V POL 40 x 190 / shelf*  
42 x 38 x 190 cm  
ID J491212



**Happy O POL 40 x 153**  
*Happy O POL 40 x 153 / shelf*  
42 x 38 x 153 cm  
ID J491112

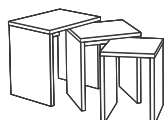

**Pikolo klub set**  
*Piccolo club set*  
45 x 38 x 48 cm  
ID 210512



25 mm  
Univer  
Chipboard

ABS  
2 mm  
Kant traka  
Edge Band



**Krevet na sprat**  
*Bunk bed*  
205 x 96,4 x 173,5 cm  
ID J492312

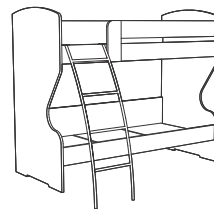

25 mm  
Univer  
Chipboard



**Happy KL POL 80 x 153**  
*Happy KL POL 80 x 153 shelf*  
80 x 38 x 153  
ID J491640



klizna vrata/slide door

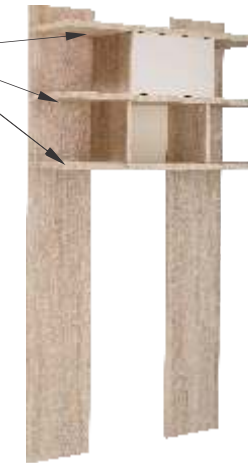

**Happy VEL POL**  
*Happy VEL POL*  
100 x 32 x 190  
ID J491540



Happy



Happy

220 cm



**Happy O1V**  
*Happy O1V*  
45 x 54 x 220 cm  
ID J491840

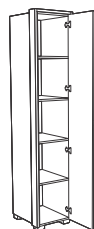

**Happy O2V**  
*Happy O2V*  
85 x 54 x 220 cm  
ID J491940

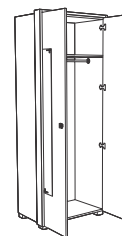

25 mm  
Univer  
Chipboard

ABS  
1 mm  
Kant traka  
Edge Band



**Happy O2V2F**  
*Happy O2V2F*  
85 x 54 x 220 cm  
ID J492040



**Happy O3V2F**  
*Happy O3V2F*  
125 x 54 x 220 cm  
ID J492140

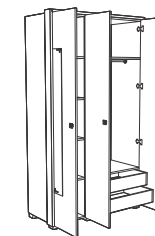

# Kompjuterski stolovi

*Computer's desks*

Eksplzivni razvoj tehnologije nameće potrebu za sve bržim obavljanjem radnih zadataka, što je moguće postići jedino u pravilno konfigurisanom radnom okruženju. Osnovna karakteristika dobro dizajniranog kompjuterskog stola je njegova maksimalna funkcionalnost. Kompjuterski stolovi kompanije Matis konstruisani su tako da vrlo brzo postaju produžena ruka korisnika.

*The explosive development of technology imposes the need for faster job performance, which can be achieved only in a properly configured work environment. The basic characteristic of a well-designed computer table is its maximum functionality. Matis's computer tables have been designed so that they quickly become an extended user's hand.*

# Happy

Kompjuterski sto "Happy 18mm"  
100 x 50 x 75 cm  
Computer desk "Happy 18mm"



Tobako Snežni hrast Trešnja  
Tobacco Snow oak Cherry



ID 492446  
snežni hrast/ snow oak



ID 492403  
trešnja / cherry



ID 492452  
tobako / tobacco

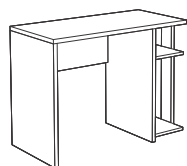

# Ana 3F

Kompjuterski sto "Ana 3F"  
130 x 60 x 75 cm  
Computer desk "Ana 3F"



Belo Hrast Tobako Snežni hrast Trešnja  
White Oak Tobacco Snow oak Cherry



ID 4703\*\*  
tobako / tobacco



ID 4703\*\*  
snežni hrast/ snow oak

ID 4703\*\*  
belo / white

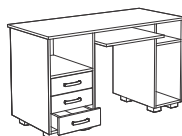

NAPOMENA Kompletna šifra elementa se dobija zamenom zvezdica \*\* sa dve cifre iz prikazanih dezena.  
NOTE: The complete code of an element is obtained by replacing stars\*\* with two digits of the displayed pattern.

# Dionis

Kompjuterski sto "Dionis"  
100 x 55 x 136 cm  
Computer desk "Dionis"

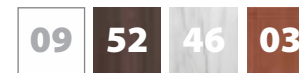

Belo Tobako Snežni hrast Trešnja  
White Tobacco Snow oak Cherry



ID 4702\*\*  
snežni hrast/ snow oak



ID 4702\*\*  
tobako / tobacco

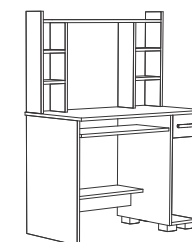

# Matis Wood



## Kompletna fabrička linija za proizvodnju nameštaja od masiva

*Factory line for of solid wood furniture production*

Najmlađa fabrika u okviru Matis Grupe. Moderno osmišljena. Nastala je kao rezultat nastojanja da našu ponudu upotpunimo nameštajem od masiva. I u ovoj fabrici primenili smo usvojene izvorne principe poslovanja – kvalitetni materijali, visokoobrazovani ljudski resursi i najsavremenija tehnologija za obradu drveta. Ponuda nameštaja od masiva i već poznata ponuda pločastog i tapaciranog nameštaja, dušeka i jastuka, MATIS GROUP čini jedinstvenim proizvođačem u regionu i šire.

*The youngest factory within the Matis Group. Modernly designed. The factory was created as a result of efforts to complete our assortment with solid wood furniture. In this factory also, we have applied our original business principles – high quality materials, highly qualified human resources and the latest technology for wood processing. Assortment of solid wood furniture, together with upholstery furniture, mattresses and pillows makes "MATISGROUP" unique furniture manufacturer in the region and beyond.*



### 1 SIROVINE

Repromaterijali kontrolisanog kvaliteta su osnova za izradu kvalitetnog finalnog proizvoda.

#### RAW MATERIALS

*Controlled quality materials are the basis for a good quality product.*

### 2 REZANJE

Posle sortiranja sirovine na potpuno automatizovanoj liniji za rezanje, izdvajaju se najkvalitetniji delovi drveta za dalju obradu. Lasersko zadavanje mera i video praćenje procesa od strane operatera, obezbeđuju visoku preciznost i kvalitet izrezanih elemenata.

#### CUTTING PROCESS

*After sorting the raw material in a completely automated cutting line, the high quality parts of wood are separated for further processing. Laser setting and video monitoring of the process by the operators, provide high precision and quality of cut elements.*

### 3 SUŠENJE POLUPROIZVODA

Kompjuterski praćeni parametri sušenja od strane inženjera garantuju konačan kvalitet proizvoda.

#### RAW MATERIAL DRYING.

*The computer-monitored parameters of drying are supervised by engineers, thus guaranteeing the final product quality.*

### 4 CNC OBRADA

Osušeni elementi se obrađuju na kompjuterski upravljanim mašinama.

#### CNC PRODUCTION

*Dried lumber is processed on a computer-controlled (CNC) machines.*



5



6



7



7

## 5 KONTROLA KVALITETA

Tačno definisanim procedurama procesne i završne kontrole od strane tehničke službe garantuje odličan krajnji proizvod.

### Quality control

Exactly defined procedures and process of final inspection by the technical service guarantees an excellent final product.

## 6 AUTOMATIZOVANO FARBANJE I LAKIRANJE

Automatizovane linije za farbanje, osim velike produktivnosti donose i stalni kvalitet ofarbanih elemenata.

### AUTOMATED PAINTING AND VARNISHING

Automated painting lines, in addition to high productivity, also bring the permanent quality of painted elements.

## 7 PAKOVANJE I ZAŠTITA

Posle završenih kontrola, elementi nameštaja se pakuju u kartonske kutije. Osetljiva mesta sklona oštećenjima pri transportu, zaštićena su oblogama od stiropora.

### PACKAGING AND PROTECTION

After the completed control, furniture elements are packed in cardboard boxes. Sensitive areas prone to transport damage are protected by covers of Styrofoam.

**Matis**  
NAMEŠTAJ / FURNITURE



**VRHUNSKI KVALITET • SAVREMEN DIZAJN  
PRISTUPAČNE CENE**

**TOP QUALITY • CONTEMPORARY DESIGN  
AFFORDABLE PRICES**

Osnovna delatnost firme Matis je serijska proizvodnja nameštaja od pločastih materijala. Obezbeđenje kvalitetnih materijala, upošljavanje visoko stručnih ljudskih potencijala, kao i primena savremenih tehnologija u proizvodnji, bili su principi početne strategije razvoja firme. Vođen tim principima, Matis je uspešno dizajnirao, projektovao i plasirao na tržište asortiman od preko 1000 proizvoda. Proizvodnja je organizovana kroz fleksibilan tehnološki sistem sa kompjuterski upravljanim mašinama. Kao rezultat istrajnosti u primeni početnih principa, danas se naši proizvodi prepoznaju po vrhunskom kvalitetu, savremenom dizajnu i veoma pristupačnim cenama.

*The main activity of MATIS company is serial production of chipboard furniture. The basic principles of our developmental strategy are usage of high quality materials, employment of well educated human potentials, as well as application of modern technologies in the production process. With the guidance of these principles MATIS has successfully designed, produced and placed on the market more than 1000 products. Production is well organised, through flexible technological system with CNC technology. As the result of our persistence in the following of the quoted principles, our products are nowadays recognised by high quality, modern design and very affordable prices.*



**15 000 m<sup>2</sup>**  
magacina repromaterijala  
*raw material warehouses*

**5** proizvodnih linija  
*production lines*  
**20 000 m<sup>2</sup>**

**25 000 m<sup>2</sup>**  
magacina gotovih proizvoda  
*final product warehouses*

Prateći zahteve tržišta u pogledu kvaliteta, cena i količina proizvoda, tehnološki sistem firme **Matis** projektovan je da isprati najsloženije zahteve tržišta.

Projektovan kao fleksibilni tehnološki sistem omogućava proizvodnju velikog broja raznorodnih proizvoda u manjim ili većim serijama, sa maksimalnom produktivnošću u oba slučaja.

*By following market demands in terms of quality, prices and quantity of products, technological system of Matis Company is designed to follow most complex market demands.*

*Designed as a flexible technological system it allows producing of a numerous various products in smaller or bigger series, with the maximum productivity in both cases.*

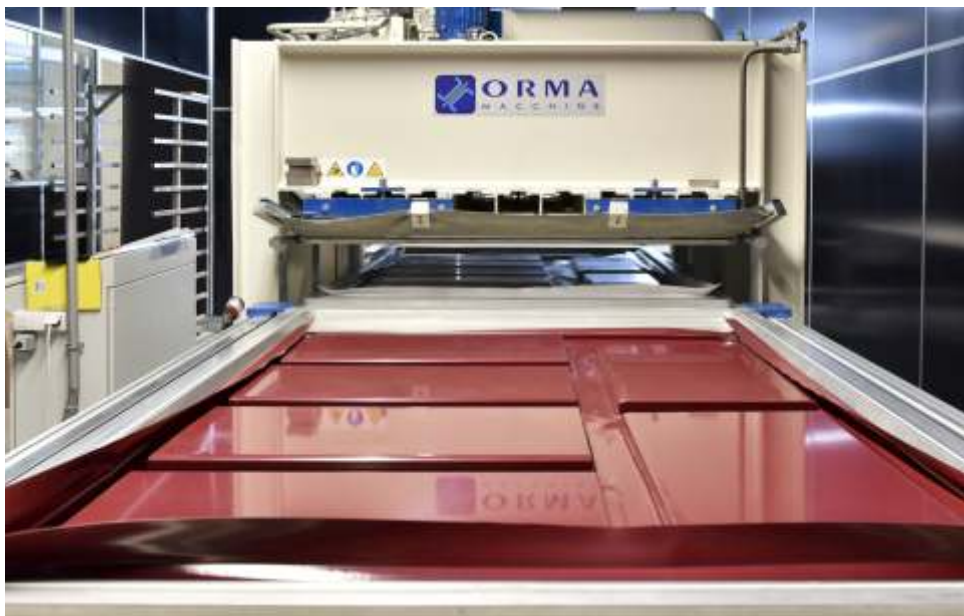

**ITALIJANSKA VAKUUM TEHNOLOGIJA IZRADE FRONTOVA OD MEDIJAPANA**  
**ITALIAN VACUUM TECHNOLOGY PREPARATION FRONT MDF**



Kompletan podsistem mašina sastoji se isključivo od kompjuterski upravljanih mašina renomiranih svetskih proizvođača. Podsistem mašina integrisan je sa transportnim sistemima tako da su vremena obrade i pomoćna vremena minimalizovana što donosi trenutno najvišu produktivnost u industriji nameštaja. Trenutno se tehnološki sistem sastoji od 5 proizvodnih linija (20.000 m<sup>2</sup>) koje se svake godine, prateći svetske trendove, dopunjuju ili menjaju isključivo novim mašinama većeg kapaciteta i sa većim stepenom automatizacije proizvodnog procesa.

Upravljanje kvalitetom proizvoda vrši se, kako procesnim kontrolama kvaliteta od strane kontrolora kvaliteta uzorkovnjem, tako i izlaznom kontrolom gotovih proizvoda.

Magacinski prostori repromaterijala od 15.000 m<sup>2</sup> i gotovih proizvoda od 25.000 m<sup>2</sup>, kao i lager od 2.000.000 € garantuju kontinuitet isporuke Matisovih proizvoda.

*Complete machine subsystem consists exclusively of computer-controlled machines made by renowned world manufacturers. The machine subsystem is integrated with transport systems so that processing time and additional time are minimized, which is currently bringing the highest productivity in the furniture industry. Currently, the technological system consists of 5 production lines (20.000 m<sup>2</sup>), that each year, by following world trends, are supplemented or changed only for new machines with higher capacities and with higher degree of automation of the production process.*

*Management quality of products is done by quality control by sample quality controller, as well as by output control of final products.*

*Storage spaces of raw material of 15.000 m<sup>2</sup> and 25.000 m<sup>2</sup> of final products, as well as the stock of 2.000.000 euros guarantee continuity of supply of Matis products.*



# MatisGROUP

Matis

Matis Mebl

Matis Wood

Matisan

# FURNITURE 2018

## **MatisGROUP**

Šume bb  
32250 Ivanjica - SRBIJA  
+381 0 32 651 159   
+381 0 032 651 060   
office@matis.rs   
www.matis.rs 

